

INFORMATION TO USERS

This manuscript has been reproduced from the microfilm master. UMI films the text directly from the original or copy submitted. Thus, some thesis and dissertation copies are in typewriter face, while others may be from any type of computer printer.

The quality of this reproduction is dependent upon the quality of the copy submitted. Broken or indistinct print, colored or poor quality illustrations and photographs, print bleedthrough, substandard margins, and improper alignment can adversely affect reproduction.

In the unlikely event that the author did not send UMI a complete manuscript and there are missing pages, these will be noted. Also, if unauthorized copyright material had to be removed, a note will indicate the deletion.

Oversize materials (e.g., maps, drawings, charts) are reproduced by sectioning the original, beginning at the upper left-hand corner and continuing from left to right in equal sections with small overlaps. Each original is also photographed in one exposure and is included in reduced form at the back of the book.

Photographs included in the original manuscript have been reproduced xerographically in this copy. Higher quality 6" x 9" black and white photographic prints are available for any photographs or illustrations appearing in this copy for an additional charge. Contact UMI directly to order.

UMI

A Bell & Howell Information Company
300 North Zeeb Road, Ann Arbor MI 48106-1346 USA
313/761-4700 800/521-0600



UNIVERSITY OF CALIFORNIA
Los Angeles

The Morphosyntax of Applicatives

A dissertation submitted in partial satisfaction of the
requirements for the degree Doctor of Philosophy
in Linguistics

by

Deogratias Stan Ngonyani

1996

UMI Number: 9634315

Copyright 1996 by
Ngonyani, Deogratias Stan

All rights reserved.

UMI Microform 9634315
Copyright 1996, by UMI Company. All rights reserved.

This microform edition is protected against unauthorized
copying under Title 17, United States Code.

UMI
300 North Zeeb Road
Ann Arbor, MI 48103

© Copyright by
Deo Gratias Stan Ngonyani
1996

The dissertation of Deogratias Stan Ngonyani is approved.

Chris Ehret

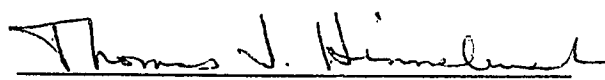
Thomas J. Hinnebusch

Dominique Sportiche

Hilda Koopman, Committee Chair

University of California, Los Angeles

1996

Mtu kwa usemi wake, wanyama milio yao,
Simba kwa ngurumo yake, tisho kuu kwa kondoo,
Bali kwa makinda yake, hupendeza masikio,
Na tai kwa wimbo wake, mbalimbali na jogoo,
Titi la mama litamu, jingine halishi hamu.

From "Kiswahili" by Shaaban Robert (1960)

Pambo la Lugha

TABLE OF CONTENTS

TABLE OF CONTENTS..... iv
SYMBOLS AND ABBREVIATIONS.....x
ACKNOWLEDGMENTSxi
VITAxiii
ABSTRACT OF THE DISSERTATION..... xiv

CHAPTER ONE

INTRODUCTION

1. The Problem..... 1
2. Notes on the Data..... 1
 2.1 The Languages..... 1
 2.2 The Applicative and Other Verb Extensions 2
3. Theoretical Overview 7
 3.1 X-bar Theory..... 7
 3.2 θ -Theory 8
 3.3 Argument Licensing..... 9
 3.4 Incorporation..... 9
4. Organization of the Dissertation..... 12

CHAPTER TWO

THE APPLICATIVE CONSTRUCTION

0. Introduction..... 14
1. Basic Description..... 15
 1.1 Morphology..... 15
 1.2 Interpretation..... 18
 1.3 Alternative Expressions..... 19
2. Object Properties 24
 2.1 Object Order..... 24

2.1.1 VAPP AO DO	25
2.1.2 VAPP DO AO	25
2.2. Object Cliticization.....	27
2.2.1 Clitic Doubling of the Applied Object.....	32
2.2.2 Clitic Doubling of the Theme/Patient	33
2.3. Passivization in Swahili.....	37
2.3.1 Passivization of the Applied Objects.....	38
2.3.2 Passivization of the Direct Object	39
2.4 Reciprocalization	40
2.4.1 Reciprocal Interpretation of the Applied Object.....	41
2.4.2 Reciprocal Interpretation of the Direct Object	42
2.5 Wh-Extraction.....	44
2.5.1 Wh-extraction of the Applied Object Without Object Agreement.....	44
2.5.2 Wh-Extraction of the Direct Object Without Object Agreement	45
2.5.3 Wh-Extraction of Applied Object with Object Agreement.....	46
3. A Typology of Applicatives	47
4. Previous Analyses	49
4.1 Lexical-Functional Grammar.....	49
4.1.1 Principles of LFG.....	50
4.1.2 Analysis of Applicatives	51
4.1.3 The Contribution of LFG.....	52
4.2 The Structural-Syntactic Approach	54
4.2.1 Baker (1988a, 1988b, 1990, 1992).....	55
4.2.2 Marantz (1993).....	58
4.2.3 Hoffman (1991)	66
5. Summary.....	71

CHAPTER THREE

VP ELLIPSIS IN NDENDEULE AND SWAHILI APPLICATIVES

0. Introduction.....	72
----------------------	----

1. VP Ellipsis	73
2. VP Ellipsis in Ndendeule and Swahili.....	75
2.1 Basic Ellipsis Facts.....	75
2.2 Analysis.....	77
2.3 V Movement in Ndendeule and Swahili.....	79
2.3.1 Adverbs	79
2.3.2 Negation in Ndendeule.....	81
2.4 English Vs Bantu VP Ellipsis.....	82
3. Alternative Analysis	86
3.1 Object Agreement.....	86
3.2 Lack of Double Clitics.....	88
3.3 Deletion of Non-objects.....	89
3.4 VP Deletion and Idiom Chunks.....	90
3.5 Sloppy Identity Interpretation	91
4. Some Differences Between English and Ndendeule/Swahili.....	93
5. VP Ellipsis as a Diagnostic Tool on Applicative Constructions	95
5.1 Predictions.....	95
5.2 Benefactive Applicatives	96
5.3 Instrumental Applicatives	99
5.4 Locative Applicatives.....	101
5.5 A Summary of VP Ellipsis in Applicative Constructions.....	102
6. Conclusion	103

CHAPTER FOUR

BENEFACTIVE APPLICATIVES

0. Introduction.....	106
1. Basic Facts	107
1.1 Object Properties.....	107
1.1.1 Word Order.....	107
1.1.2 Clitic Doubling.....	108

1.1.3 Passivization.....	113
1.1.4 Reciprocalization.....	114
1.1.5 Reflexive.....	115
2. Benefactive Applicative Structure.....	115
2.1 Issues.....	116
2.2 The Applicative Predicate.....	117
2.3 Explaining the Object Properties.....	118
2.3.1 The Order of Full DPs.....	118
2.3.2 Cliticization.....	119
2.3.3 Clitic Doubling.....	120
2.3.4 Reflexivization and Reciprocalization.....	121
2.3.5 Wh-movement.....	123
2.3.6 Distributive Quantifiers.....	125
3. Asymmetries.....	128
3.1 Object Asymmetry.....	128
3.2 Symmetrical Object Languages.....	130
3.3 Benefactive-Instrumental Asymmetry.....	133
4. Benefactive Applicative Type.....	133
5. Conclusion.....	135

CHAPTER FIVE

INSTRUMENTAL APPLICATIVES

0. Introduction.....	136
1. Restrictions.....	136
1.1 Restrictions on Phonologically Realized DPs.....	137
1.1.1 Wh-Constructions.....	137
1.1.1.1 Infinitival Relatives.....	137
1.1.1.2 Finite Relative Clauses.....	141
1.1.1.3 Topicalization.....	142
1.1.2 Cliticization.....	146

1.2 Restrictions on Cliticization	147
1.3 Restrictions on Reciprocal and Reflexive Interpretation	149
1.4 Problems with Passivization.....	150
1.5 Distributive Quantifier-Pronoun Binding.....	151
2. Analysis	152
2.1 Review of the Issues.	152
2.1.1 Questions	152
2.1.3 Desirable Results	153
2.2 The Structure of Instrumental Applicatives.....	153
2.2.1 Basic Structure	154
2.2.1.1 VP Ellipsis	154
2.2.1.2 Verb Incorporation	155
2.2.2 Argument Licensing.....	156
2.3 QNP-Pronoun	160
3. A Typology of Instrumentals.....	166
3.1 Aide vs Tool Instruments.....	167
3.2 Evidence for the Typology.....	168
3.3 Accounting for the Typology.....	172
4. Motive Applicatives.....	178
5. Conclusion	181

CHAPTER SIX

LOCATIVE APPLICATIVES

0. Introduction.....	183
1. The Locative Argument.....	184
1.1 Morphological Properties.....	184
1.2 Meaning	189
1.3 Distributional Properties of Locative Arguments.....	190
1.3.1 Locative Phrases as DPs.....	190
1.3.2 Locatives as PPs.....	193

1.4 The Structure of the Locative Phrase.....	199
2. Locative Applicative Structure	202
3. Accounting for the Syntactic Properties.....	204
3.1 Syntactic Properties.....	204
3.1.1 Object Order	204
3.1.2 Cliticization.....	204
3.1.3 Passivization.....	206
3.1.4 Topicalization.....	206
3.2 VP Raising.....	207
3.3 Passive and Locative Inversion.....	210
4. Conclusion	214
 Bibliography	 216

SYMBOLS AND ABBREVIATIONS

AO	Applied Object
APP	Applicative
BEN	Benefactive
CAUS	Causative
DO	Direct Object
FT	Future Tense
FV	Final Vowel
IMP	Imperfective
INST	Instrumental
LOC	Locative
OA	Object Agreement
PASS	Passive
PERF	Perfective
PI	Present Imperfect
PRT	Present Tense
PST	Past Tense
REC	Reciprocal
REF	Reflexive
REL	Relative
SA	Subject Agreement
ST	Stative
SUJ	Subjunctive

ACKNOWLEDGMENTS

First of all, I would like to thank all my teachers. I would like to express my deepest gratitude to my dissertation committee for their guidance, insights and understanding. I thank Hilda Koopman, the chair of the committee, for her guidance and penetrating insights into every subject we discussed. I thank her for her patience as she suffered through every paragraph of my often confusing prose as she tried to guide me through a systematic study of my languages. She has always been available for me. I thank Dominique Sportiche for his understanding and for asking eye-opening and stimulating questions. Tom Hinnebusch helped me sharpen my understanding of the various facts especially from the comparative historical perspective. We spent a lot of time discussing the raw data. My thanks to Chris Ehret, for lending me an ear as I babbled about the subject. Although I have not always followed their suggestions, without the help I got from these scholars, this study would have been without most of the insights.

I benefited a lot from many stimulating discussions and exchanges with various friends. In particular, I thank the Syntax-Semantics Seminar participants. I thank Anoop Mahajan for very insightful comments. I appreciate the companionship and fruitful discussions of colleagues: Manuel Espanol-Echeverria, Murat Kural, Nhlanhla Thwala, Felicia Lee, Matt Pearson and Jeanette Schaeffer. Critical grammaticality judgments of the Swahili examples were obtained at different times from friends such as Angaluki Muaka, Alwiya Omar, Hassan Omar Ali and from my wife, Suma.

My Swahili students deserve a special mention. Their curiosity and many questions about the grammar of Swahili helped me reflect more and so

sharpen my understanding of Bantu structure. I would like to mention R. Gonzales, C. Fourshey, M. Goldman, E. Fultz, M. Goldman, J. Smith, D. D'Souza, S. Faison, N. Phim, S. Kadoi and K. West. Their enthusiasm was very inspiring to me. I would like to thank Elissa Fultz for helping with editing.

My studies at UCLA were made possible by the support from the Department of Linguistics and the African Studies Center, UCLA. For this, I thank Russ Schuh, Tim Stowell and Edmond Keller. Special thanks are due to Tom Hinnebusch (Baba Mdogo), Russ Schuh and Hilda Koopman for being real friends, for understanding and for helping me out when I was in trouble.

Finally, I wish to thank my family. My wife Suma gave me strength and support. She has been very understanding. I thank my sons Mike and Stan for their understanding for I was not always there when they needed help with their homework or other activities. Mzee Stanislaus Ngonyani, Rai and folks at Nakawale-Mkongo were the first to inspire me. I thank them for bearing with our long absence.

All shortcomings of the study are my responsibility.

To all I say, "ASANTENI SANA".

VITA

December 31, 1957 Born, Songea, Tanzania

1980 Diploma in Education
Dar es Salaam College of National Education

1980-1982 Secondary School Teacher
Ifunda, Tanzania

1985 B.A. (Ed)
University of Dar es Salaam
Tanzania

1985-1986 Secondary School Teacher
Mzumbe, Tanzania

1988 M.A., Linguistics
University of Dar es Salaam
Tanzania

1988-1991 Assistant Lecturer
Department of Foreign Languages and Linguistics
University of Dar es Salaam
Tanzania

1994 M.A., Linguistics
University of California, Los Angeles

1991-1995 Teaching Assistant
Department of Linguistics
University of California, Los Angeles

ABSTRACT OF THE DISSERTATION

The Morphosyntax of Applicatives

by

Deogratias Stan Ngonyani

Doctor of Philosophy in Linguistics

University of California, Los Angeles, 1996

Professor Hilda Koopman, Chair

The Bantu applied verb suffix {-il-} can license a variety of arguments which can be interpreted as beneficiary, recipient, goal, maleficiary, instrument, motive, reason or locative. This study of Ndendeule and Swahili applicatives shows that applicatives can be grouped into three types: (i) Beneficiary, goal and maleficiary; (ii) instrumental, motive and reason; (iii) locative. This classification is arrived at by examining various syntactic properties, object order, cliticization, passivizability, the possibility of being interpreted as a reciprocal or reflexive, and wh-extractability.

In order to analyze the applicatives, VP ellipsis is established as a diagnostic of the constituent structure and then applied to the three applicative types. Interesting results are obtained in that all applicatives form stacked VPs with the theme/patient and the verb root as the smallest VP. This VP is contained within the applicative VP containing the applicative argument. The applicative VP is headed by the applied affix. In this

incorporation account, the verb root always adjoins to the left of the host, the applicative head yielding the V+APP order.

The proposed structure provides a direct explanation for the behavior of the benefactive applicatives in which the applied object exhibits primary object properties. Major problems are encountered with respect to instrumental applicatives. (i) Generally, two lexical DPs do not occur in postverbal position. (ii) Only the direct object can cliticize, or be interpreted as reciprocal or reflexive. (iii) There are no consistent results with respect to passivization. (iv) There are two structural types of instruments, tool and aide. The study proposes to account for (i) and (ii) by a movement of the lower predicate to a position higher than the applied object. This places the direct object closer to the clitic position. The main distinguishing feature of locative applicatives is the fact that the locative argument has DP as well as PP features. The analysis of applicatives structurally arranges some thematic roles as: agent > beneficiary > instrument > theme/patient.

CHAPTER ONE

Introduction

1. The Problem

This dissertation is a study of the syntax and morphology of the applicative morpheme {-il-} in Bantu languages. The applied suffix on the verb licenses an additional argument for the verb which is called an applied object. I investigate two kinds of relationship the affix enters into: (i) the relationship between the applied affix and the verb, and (ii) the relationship between the applied affix and the various arguments of the applicative verb. I will show that all these relationships can be accounted for structurally in the syntax (as opposed to semantically or lexically). The affixation, the syntactic properties of the objects as well as the hierarchy of thematic roles can and should be explained using syntactic primitives and principles.

2. Notes on the Data

2.1 *The Languages*

The data for this study come mainly from the two Eastern African Bantu languages of Ndendeule and Swahili. Ndendeule is spoken by about 79,000 people (Grimes, 1992) in southern Tanzania in Ruvuma Region. It is not listed in Guthrie's classification of Bantu languages (Guthrie, 1948, 1968-71). Its closest relative is Ngindo classified by Guthrie as P14 (Ngonyani, 1994). It is linguistically closely related to Matengo, Mpoto, Ndengereko, Ruihi and Matumbi, all of which belong to the Rufiji-Ruvuma language group (Hinnebusch, 1983; Nurse and Hinnebusch, 1993; Nurse, 1988). Swahili is a

Northeast Coast Bantu language (Nurse and Hinnebusch, 1993) which is now widely spoken in East and Central Africa. It is classified as G42 by Guthrie (1948, 1968-71). Swahili is the *lingua franca* of East and Central Africa. Geographically, the Swahili area on the coast of East Africa is close to the Rufiji-Ruvuma area, and is spoken in the Rufiji area too.

While there exist descriptions and studies on Swahili syntax, there exists none on Ndendeule. The Swahili which is studied here is the standard dialect commonly known as Standard Swahili (Kiswahili Sanifu) originally based on the Zanzibar dialect. The examples from Ndendeule are all generated by myself¹. The judgements on Ndendeule are all mine. Apart from data from different studies, I have made extensive use of various speakers of Standard Swahili including my family. There is considerable similarity between Ndendeule and Swahili in the grammar. Wherever they differ I do point that out.

2.2 The Applicative and Other Verb Extensions

As in other Bantu languages, Ndendeule and Swahili have verb suffixes (verb extensions) which effect grammatical function change of the arguments. One of those verb extensions is the applicative, {-il-}. The following two sentences illustrate the contrast between a non-applicative verb (i.e. a verb without an applicative suffix) and an applicative verb (i.e. a verb with an applicative suffix).

¹ Ndendeule is my first language. I grew up in an area where, like most parts of Tanzania, Swahili is a language that is used at the market, at the store, at the mosque, at the church, in school, in public occasions, and many other public domains. For this reason I was able to learn Swahili before I went to school. I was introduced to English in the third grade.

Ndendeule

- (1) a. n-gheni a-ki-hemɛl-a ngoβo
1-guest 1-PST-buy-FV 10cloth
the guest bought clothes
- b. n-gheni a-ki-n-hemɛl-ɛl-a mw-ana ngoβo
1-guest 1SA-PST-1OA-buy-APP-FV 1-child 10cloth
the guest bought the child clothes

The applied suffix, in this case /-ɛl-/, licenses the presence of an additional argument, "the child". The verb "to buy" which has two basic arguments in (1a), has three arguments when the applied suffix is added in (1b).

In example (1b), the applied object is interpreted as the beneficiary. However, not all applied objects can be interpreted as beneficiaries. The interpretation of the applied object depends on the verb the applied object combines with and the properties of the object itself selected by the verb. The following examples illustrate different interpretations of the applied objects and define the range of data that is studied in this dissertation.

Ndendeule

- (2) a. mayi a-ki-βa-telek-ɛl-a βa-na ch-akulya (Benefactive)
1mother 1SA-PST-2OA-cook-APP-FV 2-child 7-feed
mother cooked the children some food
- b. mbuya a-ki-βa-kang-i βa-chongolo βa-chikana (Goal)
1grandma 1SA-PST-2OA-push-APP 2-boy 2-girl
grandma pushed the girls to the boys
- c. ma-yani ya-ki-βa-yomɔl-ɛl-a ma-chi βa-lumba (Malefactive)²
6-baboon 6SA-PST-2OA-finish-APP-FV 6-water 2-hunter
the baboons finished the hunter's water
- d. ma-yanga βa-ki-kayul-il-a ki-βeya (Instrumental)
6-stone 2SA-PST-break-APP-FV 7-pot
the stones, they broke the pot with them

² This object order is grammatical when there is object agreement as in this case.

- e. β a-lumba β a-ki-hyem-el-a m biya (Motive)
 2-hunter 2SA-PST-hunt-APP-FV 10money
 the hunters hunted for money
- f. β a-lumba β a-ki-tul-il-a nyama pa-manyahi (Locative)
 2-hunter 2-PST-skin-APP-FV 9animal 16-grass
 the hunters skinned the animal on the grass
- g. m-wana a-ki-lel-el-a ki-hembe (Reason)³
 1-child 1SA-PST-cry-APP-FV 7-knife
 the child cried for a knife

Similar examples can be constructed for Swahili as shown below.

Swahili

- (3) a. mama a-li-wa-pik-i-a wa-toto ch-akula (Benefactive)
 1mother 1SA-PST-2OA-cook-APP-FV 2-child 7-food
 mother cooked the children some food
- b. bibi a-li-wa-sukum-i-a wa-vulana 2-wasichana (Goal)
 1grandma 1SA-PST-2OA-push-APP 2-boy 2-girl
 grandma pushed the girls to the boys
- c. nyani wa-li-wa-maliz-i-a ma-ji wa-windaji (Malefactive)
 2baboon 2SA-PST-2OA-finish-APP-FV 6-water 2-hunter
 the baboons finished the hunter's water
- d. ma-we, wa-li-vurj-i-a ch-ungu (Instrumental)
 6-stone 2SA-PST-break-APP-FV 7-pot
 the stones, they broke the pot with them
- e. wa-windaji wa-li-wind-i-a pesa (Motive)
 2-hunter 2SA-PST-hunt-APP-FV 10money
 the hunters hunted for money
- f. wa-windaji wa-li-chun-i-a m-nyama ma-nyasi-ni (Locative)
 2-hunter 2-PST-skin-APP-FV 1-animal 16-grass-LOC
 the hunters skinned the animal on the grass
- g. m-toto a-li-lil-i-a ki-su (Reason)
 1-child 1SA-PST-cry-APP-FV 7-knife
 the child cried for a knife

³ The label may not be accurate. However, the important thing is to note that this applied object has a distinct interpretation.

(5) Ndendeule and Swahili Noun Classes

	NDENDEULE		SWAHILI	
CLASS	EXAMPLE	GLOSSES	EXAMPLE	GLOSSES
1	mu-ndu	person	m-tu	person
2	βa-ndu	person/people	wa-tu	persons
3	n-kongo	tree	m-ti	tree
4	mi-kongo	trees	mi-ti	trees
5	li-hamba	leaf	tunda	fruit
6	ma-hamba	leaves	ma-tunda	fruits
7	ki-tombi	hill	ki-su	knife
8	hi-tombi	hills	vi-su	knives
9	mbuhi	goat	njia	path, way
10	mbuhi	goats	njia	paths, ways
11	lu-hyoβo	(finger) nail	u-kucha	(finger) nail
12	ka-mbuhi	tiny goat	-	-
13	tu-mbuhi	tiny goats	-	-
14	u-hwangi	lie, falsehood	u-wongo	lie
15	ku-yemba	to sing/singing	ku-imba	to sing/singing
16	pa-likuta	at the hut	nyumba-ni	at the house/home
17	ku-likuta	to/at the hut	nyumba-ni	to the house
18	mu-likuta	in the hut	nyumba-ni	in the house
21	yu-mbuhi	huge goat	-	-

All glosses on nouns indicate noun class numbers even when there is no overt prefix as in some Swahili Class 5 items.

3. Theoretical Overview

This study is conducted within the approach of syntactic theory known as Principles and Parameters as developed in Chomsky and Lasnik (1993), Chomsky (1982, 1986a, 1986b, 1991, 1993) and other related publications. I will highlight assumptions underlying this study with respect to X-bar theory, and θ -theory since these are the modules of the theory which define the relationships I investigate in this study and form the basis of my proposals. I will also briefly state my assumptions on incorporation.

3.1 X-bar Theory

X-bar Theory unifies all structures into a simple set of basic relations in a phrase (Chomsky, 1982, 1986b, 1993; Stowell, 1981). Call this phrase XP. The relations are defined by the lexical entry X. This X, which is the head of the phrase, has two kinds of relations: the first is the relation between this X and its complement, YP for example. This relation is also known as Head-Complement relation. The second relation is with its specifier, ZP for instance. This relation is also called Spec-Head relation. The conventional representation of these relations is shown in (6) below.

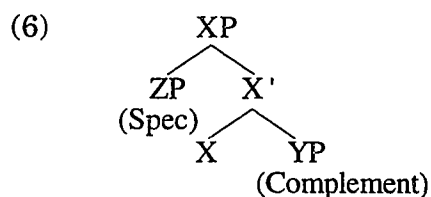

There are four important properties of this structure. The first property is that the properties of the phrase are determined by the head of the phrase. In the structure (6), the phrase is an XP because it is headed by X. This

property is called endocentricity (Jackendoff, 1977). The second property is that the head enters into two kinds of relations: the head-complement relation as X - YP in (6) above and Spec-Head relation as ZP- X. The third property is that the head imposes selectional restrictions on the specifier and the complement. Specifically, X imposes selectional restrictions on Y, the head of YP, and on Z, the head of ZP and therefore determines the phrases in those two positions. However, X cannot impose selectional restrictions on phrases contained in ZP or YP. The fourth property is binary branching based on the proposal by Kayne (1984). The head takes only one complement which leads to stacked structures such as the stacked VPs proposed by Larson (1988).

3.2 θ -Theory

The theory which deals with how heads such as verbs assign semantic roles is called θ -theory. A verb entry, for example, is specified in the lexicon for arguments it can take. It specifies the thematic grid, in Stowell's terminology (Stowell, 1981). Each argument of the verb is assigned a thematic role or θ -role (theta role). There is a restricted number of roles such as agent, patient, theme, experiencer, beneficiary, goal and location.

In terms of the structure, I will assume three features of θ -theory. The first feature is a consequence of X-bar structure that the relationship between the θ -role assigner and the argument assigned the role must be local. Secondly, θ -roles can be assigned internally by the head as is the case of complement, or it may be assigned compositionally by a predicate (Chomsky, 1981; Hale and Keyser, 1993). The third feature is the θ -criterion which states:

- (7) Each argument bears one and only one θ -role, and each θ -role is assigned to one and only one argument. (Chomsky, 1981:36)

This ensures there is no argument which is assigned two θ -roles simultaneously.

3.3 Argument Licensing

Argument licensing is manifested in two ways: (i) by features on the DP and (ii) by agreement. The former is in the domain of Case Theory. Case Theory is concerned with assignment of certain formal properties of overt DPs in licensed positions. If a head assigns Case by agreement, it assigns Case to a DP in its Spec position. Agreement is a morphological spellout of the relationship between a head and its specifier (Chomsky, 1986b, 1993). It is manifested in the ϕ -features (gender, number, person) of the phrase in the Spec inflected on the head.

3.4 Incorporation

The relationship between the applied suffix and the verb is a relationship of elements at sub-zero level. This relationship is syntactic. There are three broad assumptions which I take into consideration:

- (a) The affixes have a categorial status which is evident in the selectional restrictions which they exhibit (cf. Fabb (1988) on English suffixes).
- (b) The verbs and their suffixes form complex verbs which are derived by verb movement and obey the head movement constraint (HMC) which states that:

- (8) An X^0 may only move into the Y^0 which properly governs it. (Travis, 1984:131)

This means that head movement must be local (Travis, 1984; Koopman, 1984; Baker, 1988). The moved head leaves behind a trace that must be properly governed. The appropriate definition of government here is the one provided by Sportiche (1990) in terms of immediate command (i-command) as follows:

- (9) a. Government
 A governs B iff A I-commands B and no Barrier for B intervenes between A and B.
 b. I-commands B iff a sister of A contains B.
 (Sportiche, 1990:28)

This means that only constituents of the sister to the head are governed by the head. Adjuncts and items in Spec position are not governed by the head. The sister of the head is its complement. The head of the complement may move to the head that subcategorizes for the complement. The head of the specifier in the complement may also be moved to the head that subcategorizes for the complement.

The following are the possible head movements which satisfy the above conditions (Koopman, 1994):

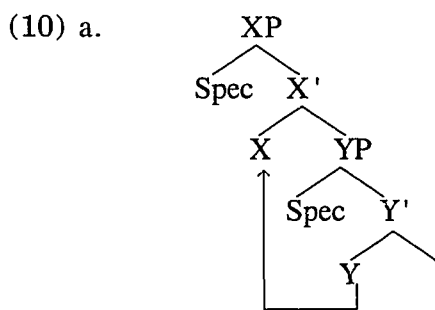

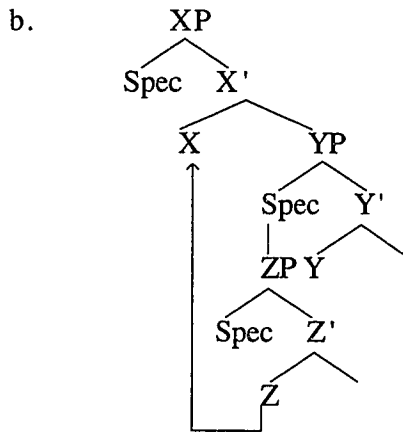

The structure shown in (10a) shows the head of the complement raising to incorporate into the governing head, X. In (10b), the head of the specifier is what incorporates into the governing head, X.

A third possibility is when a head to which another head has incorporated moves out to a higher head. This is excorporation. The structure will be as follows.

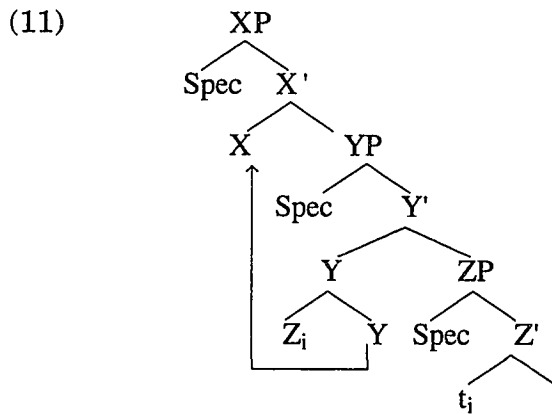

The head Z moves from the complement ZP and incorporates into Y. Y is the head of YP. In order to move, it must go to a higher head.

(c) The process of incorporation always adjoins the moved head to the left of the host (Kayne, 1994). In the structures presented in (10) above, the surface order of the element is going to be Y+X and Z+X. This accounts for the effects described by Williams (1981) as the Right Head Rule (RHR), the generalization that head affixes appear on the right side, and for the Mirror Principle of Baker (1985) the generalization that morphological structure reflects syntactic structure.

4. Organization of the Dissertation

This dissertation is divided into six chapters proceeding from the general to the more specific. I introduce the topic and the problem in Chapter 1, and outline the basic patterns of the applicative construction in Chapter 2. A careful examination of the various applied objects will show that the different applied objects behave differently. I will argue on the basis of this that applicatives should be classified into three types whose prototypes are benefactive, instrumental and locative. This fundamental typology has not been recognized by previous studies on Bantu applicatives where the main focus has been on benefactive applicatives.

Furthermore, previous studies have not attempted a constituent structure analysis of the applicatives. I will develop and apply a diagnostic test for Ndendeule and Swahili VP constituency in Chapter 3. I will show that both languages must be assumed to have a process of VP ellipsis. VP ellipsis provides a valuable diagnostic for applicative predicates. It reveals that the applicative construction consists of two stacked VPs. The minimal VP

contains the verb root and the direct object. The higher VP contains the applied object. I conclude this higher VP is headed by the applied affix.

Chapter 4 examines the benefactive applicative construction which is closest to the proposed universal applicative structure. The syntactic properties of the benefactive applicatives are explained in a straightforward way from the structure. It is the applied object which appears before the direct object, can cliticize, and can get a reciprocal or reflexive interpretation.

Chapter 5 deals with the particular problems posed by instrumental applicatives. According to the VP ellipsis diagnostic, the instrument is generated in a position higher than the direct object. However, it is the direct object only which can cliticize, and get reciprocal or reflexive interpretation. Furthermore, there are restrictions on phonologically realized object DPs. Only one DP may appear in postverbal position. To circumvent this problem, the instrumental applicative wh-moves one of the objects or cliticizes the direct object. The restriction is lifted when one of the objects is a distributive quantifier binding into the other. Moreover there are two types of instruments: tool and instrument, a typology which can be attributed to selectional restrictions imposed by the verb root.

In Chapter 6, a study of the locative applicatives is presented. Locative applicatives differ from other applicatives because the locative arguments have properties of both prepositional phrases and noun phrases. For this reason the licensing requirements of the locative argument are different.

CHAPTER TWO

The Applicative Construction

0. Introduction

Hale and Keyser (1993) argue that thematic roles are labels of arguments whose grammatical status is structurally determined. In Bantu languages, the same applicative morphology is responsible for licensing arguments of different semantic interpretations. Although the form of the verbal extension is the same for all applicatives, the applied objects differ in interpretation and syntactic properties. Some applied objects exhibit what has been called "primary" object properties: they must be adjacent to the verb, they can cliticize, they can be passivized and can get reciprocal interpretation, but others do not. In this chapter, I show that applied objects differ with respect to a number of syntactic and semantic properties. On the basis of their behavior, I will classify the applied objects into three types: (a) benefactive, goal and malefactive, (b) instrumental and motive, and (c) locative. The discussion raises many questions which I wish to take up in subsequent chapters.

This chapter is divided into five sections. After presenting basic descriptive facts in Section 1, I show how the different objects behave with respect to a number of criteria in Section 2: ordering with respect to the verb, the possibility of being cliticized, passivized, the possibility of getting a reciprocal interpretation, the possibility to undergo wh-extraction and c-command relation. Section 3 presents a typology of applicatives based on the

different syntactic properties. In Section 4, I review previous analyses. I consider both the lexical-functional approach and the structural-syntactic approach. A summary of the discussion and the conclusion which will lead to the next section is discussed in Section 5.

1. Basic Description

In this section, I present a description of the applicatives by examining the morphology and interpretation of applicatives. I contrast the applicatives with alternative constructions containing prepositional phrases which basically express the same meanings. I argue that the applicative construction is distinct from prepositional phrase constructions.

1.1 Morphology

Bantu languages have an applicative morpheme, {-il-} suffixed to the verb stem. This suffix seems to increase the number of arguments of the verb by one, as the Ndendeule example in (1) illustrates.

- (1) a. n-gheni a-ki-hemɛl-a ngoβo
 1-guest 1-PST-buy-FV 10cloth
 the guest bought clothes
- b. n-gheni a-ki-n-hemɛl-ɛl-a mw-ana ngoβo
 1-guest 1SA-PST-1OA-buy-APP-FV 1-child 10cloth
 the guest bought the child clothes

Both examples use the same root "buy" and contain the object of this verb. The verb in the (1b) contains an applied suffix /-ɛl-/. The verb which has the applied suffix takes another object, a beneficiary of the buying, "the child". This additional object is commonly referred to as the *applied object*.

The realization of the applicative morpheme may vary slightly. In Swahili, it is realized as /-i-/ or /-e-/ depending on the preceding vowel of the verb stem. It is /-i-/ after stems with /i,u,a/ and /-e-/ after stems with /e,o/. In V-final stems you get /-li-/ and /-le-¹/. The choice of vowel is determined by vowel harmony. The vowel schemata for Swahili is given in (2).

(2) Swahili

i	u
e	o
a	

The following are examples of applicative verbs from Swahili.

- (3)
- | | | | |
|----|----------------------------|---|---------------------------------|
| a. | -ficha
hide | → | -fichia
hide for/at/with |
| b. | -funga
close/shut/tie | → | -fungia
shut for/at/on |
| c. | -peleka
send | → | -pelekea
send to/for |
| d. | -omba
ask for something | → | -ombea
ask for something for |
| e. | -kata
cut | → | katia
cut for/at/on |

¹ The /l/ is actually part of the stem and not the suffix nor inserted by a rule (Port and Shepardson (1982)). Historical and comparative evidence shows that /l/ has been lost in many Swahili environments: e.g. Swahili: *-lea* (to raise children), Ndendeule: *-le_la*; Swahili: *mvua* (rain); Ndendeule: *hu_la*. There is also synchronic evidence which indicates that the lexical form of the applicative in Swahili is *-il-*. See for example, *-pal-i-a* → *pal-il-i-a* (to weed). Such forms are called "double applicatives" or "intensives".

Ndendeule, which has four vowel levels has vowel harmony also and the applicative morpheme is realized as /-il-/, /-el-/ or /-ɛl-/. The vowel system of Ndendeule is presented below.

(4) Ndendeule

i	u
e	o
ɛ	ɔ
a	

The applicative morpheme takes the values of the front vowels only. Thus when the last vowel of the stem is /i/ or /u/, the applicative morpheme will be /-il-/. When it is /e/ or /o/ in Ndendeule, the applicative will be /-el-/. When it is /ɛ/ or /ɔ/, the applicative will be /-ɛl-/. When the last vowel of the stem is /a/, the applicative suffix is /-il-/. The following examples illustrate the distribution of the different allomorphs of the applicative.

Ndendeule

(5) a.	-yiβa steal	→	-yiβila steal from/for
b.	-tula skin	→	-tulila skin with/for
c.	-yemba sing	→	-yembela sing for
d.	-βola teach	→	-βolela teach for/at
e.	-kema call	→	-kemela call for
f.	-tola take	→	-tolela take for

g. -kanga → -kangila
 push push for/to

Thus the only difference between Ndendeule and Swahili lies in the vowel quality of the suffix. Ndendeule has seven vowels and Swahili has five vowels.

1.2 Interpretation

Applicative objects may be assigned different interpretations, as different authors have discussed (e.g. Ashton, 1947; Trithart, 1983, Bresnan and Moshi, 1990; Kimenyi, 1980; Port, 1981). The following sentences from Ndendeule illustrate the range of different interpretations.

Ndendeule²

- (6) a. mayi a-ki-βa-telek-el-a βa-na ch-akulya (Benefactive)
 mother 1SA-PST-2OA-cook-APP-FV 2-child 7-food
 mother cooked the children some food
- b. mbuya a-ki-βa-kang-i βa-chongolo βa-chikana (Goal)
 1grandma 1SA-PST-2OA-push-APP 2-boy 2-girl
 grandma pushed the girls to the boys
- c. ma-yani ya-ki-βa-yomol-el-a ma-chi βa-lumba (Malefactive)
 6-baboon 6SA-PST-2OA-finish-APP-FV 6-water 2-hunter
 the baboons finished the hunter's water
- d. ma-yanga βa-ki-kayul-il-a ki-βeya (Instrumental)
 6-stone 2SA-PST-break-APP-FV 7-pot
 the stones, they broke the pot with them
- e. βa-lumba βa-ki-hyem-el-a mbiya (Motive)
 2-hunter 2SA-PST-hunt-APP-FV 10money
 the hunters hunted for money

² Verb-final syllables with /l/ as the onset are often deleted in Ndendeule. Since the final syllable bears a Low tone, the verb without this final syllable ends in a High tone. I have indicated such verbs with an accent on the final syllable. For example:

a-ki-βa-kang-il-a → a-ki-βa-kang-i
 1SA-PST-2OA-push-APP-FV 1SA-PST-2OA-push-APP
 she pushed them to ... she pushed them to ...

- f. β a-lumba β a-ki-tul-il-a nyama pa-manyahi (Locative)
 2-hunter 2-PST-skin-APP-FV 9animal 16-grass
 the hunters skinned the animal on the grass
- g. m-wana a-ki-l-el-el-a ki-hembe (Reason)
 1-child 1SA-PST-cry-APP-FV 7-knife
 the child cried for a knife

In these examples, we see applied objects with benefactive (6a), goal (6b), malefactive (6c), instrument (6d), motive (6e) and locative (6f) interpretations. Therefore, depending on the predicate, the additional argument may be interpreted in many different ways. The only interpretations that cannot be derived from the applicative are agent and theme/patient roles. This is true for both Ndendeule and Swahili.

1.3 Alternative Expressions

Ndendeule and Swahili have some expressions that are alternatives to applicative constructions. The alternative expressions are prepositional phrases which are optional. The following pairs of sentences from Swahili show the applicative and their alternative prepositional phrases:

Swahili

- (7) a. wa-geni wa-li-m-let-e-a zawadi m-toto
 2-guest 2SA-PST-1OA-bring-APP-FV 10present 1-child
 the guests brought the child some presents
- b. wa-geni wa-li-let-a zawadi kwa ajili ya m-toto
 2-guest 2SA-PST-bring-FV 10present for benefit of 1-child
 the guests brought gifts for the child.
- (8) a. mu-wa m-toto a-li-u-kat-i-a ki-su
 3-sugar cane 1-child 1SA-PST-3OA-cut-APP-FV 7-knife
 the sugar cane the child cut with a knife
- b. baba a-li-kat-a mu-wa kwa ki-su
 father 1SA-PST-cut-FV 3-sugar cane with 7-knife
 father cut the sugar cane with a knife

- (9) a. mw-alimu a-li-fundish-i-a wa-nafunzi ofisi-ni
 1-teacher 1SA-PST-teach-APP-FV 2-students 9office-LOC
 the teacher taught the students in the office
- b. mw-alimu a-li-fundish-a w-anafunzi katika ofisi
 1-teacher 1SA-PST-teach-FV 2-student in 9office
 the teacher taught the students in the office
- (10) a. tembo wa-li-mw-ul-i-a pesa
 1elephant 2SA-PST-1OA-kill-APP-FV 10money
 the elephant they killed it for money
- b. wa-li-wa-u-a tembo kwa sababu ya pesa³
 2SA-PST-2OA-kill-FV 2elephant for reason of 10money
 they killed elephants because of money

The prepositional phrases are underlined. These four examples illustrate alternative expressions for benefactive (7), instrument (8), locative (9) and reason/motive (10). The applicative (7a) is often ambiguous in that it can be interpreted as the child being the recipient of the presents or the bringing of the present was done in his stead. The paraphrase in (7b) disambiguates and means that the child is the recipient.

Swahili and Ndendeule differ as to how they make use of the alternative expressions. In Swahili, all applicatives have alternative prepositional phrases except for malefactive. In Ndendeule, prepositional phrase alternatives are only available for the instrumental, motive and locative. There are no alternative prepositional phrases for benefactive, goal and malefactive.

Another important feature of the alternative prepositional phrase construction is that unlike applied objects, which are obligatory once the verb takes the applied suffix, alternative prepositional phrases are optional. The

³ See footnote 1 for the verb alternation /-u-/ ~ /-ul-/.

following two pairs of sentences show that the applied object is an obligatory element⁴.

Swahili

(11) a. m-geni a-li-m-nunul-i-a m-toto ki-tabu
 1-guest 1SA-PST-1OA-buy-APP-FV 1-child 7-book
 the guest bought the child a book

b. *m-geni a-li-nunul-i-a ki-tabu
 1-guest 1SA-PST-1OA-buy-APP-FV 7-book
 the guest bought a book

(12) a. mu-wa a-li-u-kat-i-a ki-su
 3-sugar cane 1SA-PST-3OA-cut-APP-FV 7-knife
 the sugar cane she cut with a knife

b. *mu-wa a-li-u-kat-i-a
 3-sugar cane 1SA-PST-3OA-cut-APP-FV
 the sugar cane she cut with

The (a) sentence in each pair contains an applicative verb and its two objects, the direct object and applied object. When the applied object is absent, as shown in the (b) sentences, the sentence is incomplete and therefore ungrammatical. This shows that the beneficiary in (11) and the instrument in (12) behave as objects. This is true of all applied objects. Now contrast this with cases of prepositional phrases shown in the following two pairs.

Swahili

(13) a. m-toto a-li-kat-a mu-wa kwa ki-su
 1-child 1SA-PST-cut-FV 3-sugar cane with 7-knife
 the child cut the sugar cane with a knife

b. m-toto a-li-kat-a mu-wa
 1-child 1SA-PST-cut-FV 3-sugar cane
 the child cut the sugar cane

(14) a. m-geni a-li-nunu-a ki-tabu kwa ajili ya m-toto
 1-guest 1SA-PST-buy-FV 7-book for benefit of 1-child
 the guest bought a book for the child

⁴ Except in the context of VP ellipsis described in Chapter 3.

- b. m-geni a-li-nunu-a ki-tabu
1-guest 1SA-PST-buy-FV 7-book
the guest bought a book

When the prepositional phrase containing the instrument is omitted in (13b), the sentence is grammatical. Similarly, when the beneficiary complement of the preposition is omitted in (14b) the sentence is grammatical. These examples show that the prepositional phrases behave in the same way as the comparable PPs in English.

To summarize, the applicative is made by suffixing {-il-} to the verb and adding an object, the applied object. The quality of the vowel in the affix is determined by the height or openness of the preceding vowel. The applied object may receive different interpretations, probably compositionally determined. Applied objects are obligatory arguments which are distinct from their optional prepositional phrase equivalents.

From this preliminary discussion, a number of questions arise which this chapter attempts to address.

- (15) a. Do all applied objects behave in the same way?
b. If not, what are the syntactic properties of the different applied objects?
c. How should the different properties be accounted for?
d. How do the different meanings of the applied objects arise?
e. What is {-il-} and what is its function?

In order to answer these questions, I first determine how objects, both applied and direct, behave syntactically. A quick contrast between

benefactive applicatives and instrumental applicatives with respect to object order suggests that applied objects do not behave the same way. Consider the following examples. Note that in none of these examples do the verbs show object agreement.

Ndendeule

(16) a. *mayi a-ki-telek-ɛl-a βa-na ch-akulya* (Benefactive)
 mother 1SA-PST-2OA-cook-APP-FV 2-child 7-food
 mother cooked the children some food

b. **mayi a-ki-telek-sɪ-a ch-akulya βa-na*
 mother 1SA-PST-2OA-cook-APP-FV 7-food 2-child
 mother cooked the children some food

(17) a. *ma-ɣanga βa-ki-kayul-il-a ki-βeɣa* (Instrumental)
 6-stone 2SA-PST-break-APP-FV 7-pot
 the stones, they broke the pot with them

b. ??*βa-ki-kayul-il-a ki-βeɣa ma-ɣanga*
 2SA-PST-break-APP-FV 7-pot 6-stone
 they broke the pot with stones,

c. ??*βa-ki-kayul-il-a ma-ɣanga ki-βeɣa*
 2SA-PST-break-APP-FV 6-stone 7-pot
 they broke the pot with the stones

The linear order of objects in benefactive applicative shows that the applied object (benefactive) precedes the direct object. A sentence, such as (16b), in which the direct object precedes the applied object is ungrammatical. In contrast, either object order is not grammatical in instrumental applicatives as shown in (17c,d).

Therefore the answer to question (15a) is that the applied objects do not behave the same way. Besides linear ordering, there are other properties which characterize objects. These are cliticization (agreement), passivization, reciprocalization and reflexivization. These properties are extensively discussed in Bresnan and Moshi (1990). However, they do not discuss how the

different applied objects differ from each other. Kisseberth and Abasheikh (1977) point out restrictions on instrumental applicatives, restrictions which do not apply to benefactive applicatives. Baker (1992) and Alsina and Mchombo (1990) contrast object properties between benefactive applicatives and instrumental applicatives. In this study a wide range of applicatives are examined using these criteria. The question is what kinds of objects exhibit these properties. I therefore turn to the second question (15b) to examine how the different objects behave with respect to these object properties.

2. Object Properties

In this section I establish the characteristics of six applicatives: benefactive, goal, malefactive, instrumental, motive and locative. I test the applicatives to determine: (i) linear ordering possibilities, (ii) the possibility to cliticize (or trigger object agreement), (iii) passivizability, (iv) the possibility to receive reciprocal or reflexive interpretation, and (v) wh-extractability. The same diagnostics will be applied on the theme/patient objects to determine whether any of the direct objects exhibit these object properties.

2.1 Object Order

Both Ndebele and Swahili are head-initial languages. In applicative constructions, the order of the applied and non-applied object is more or less fixed. I begin by testing whether the different applied objects can precede the direct object

2.1.1 $V_{APP} AO DO$

Swahili

- (18) a. Juma a-li-nunul-i-a wa-toto vi-tabu⁵ (Benefactive)
 Juma 1SA-PST-bring-APP-FV 2-child 8-book
 Juma brought books for children
- b. m-sichana a-li-sukum-i-a wa-vulana j-ongoo (Goal)
 1-girl 1SA-PST-push-APP-FV 2-boy 5-milipede
 the girl pushed a milipede towards the boys
- c. fundi a-li-kat-i-a m-taa u-meme (Malefactive)
 1technician 1SA-PST-cut-APP-FV 3-neighborhood 11-power
 the technician cut power to the neighborhood.
- d. ??wa-toto wa-li-vunj-i-a ma-we ch-ungu (Instrumental)
 2-child 2SA-PST-break-APP 6-rock 7-pot
 the children broke the pot with rocks
- e. ??wa-windaji wa-li-wind-i-a pesa ndovu (Purpose)
 2-hunter 2SA-PST-hunt-APP-FV 10money 9elephant
 the hunters hunted the elephant for money
- f. *wa-teja wa-li-l-i-a ofisi-ni ch-akula (Locative)
 2-customer 2SA-PST-eat-APP-FV office-LOC 7-food
 the customers ate food in the office

These examples show that the applied object in benefactive, goal and malefactive follows the complex verb and precedes the direct object (18a,b,c). The locative cannot precede the direct object as the ungrammaticality of (18f) shows. The instrumental and motive sentences (18d,e) are extremely marginal and awkward.

2.1.2 $V_{APP} DO AO$

When the order of the objects is reversed with the patient/theme immediately following the verb, we obtain different results from the $V AO DO$ order.

⁵ In this context, the applied object "watoto" (children) is non-specific, non-definite.

Swahili⁶

- (19) a. *Juma a-li- nunul-i-a ki-tabu wa-toto (Benefactive)
 Juma 1SA-PST-buy-APP-FV 7-book 2-child
 Juma bought books for children
- b. *m-sichana a-li-sukum-i-a j-ongoo wa-vulana (Direction)
 1-girl 1SA-PST-push-APP-FV 5-milipede 2-boy
 the girl pushed a milipede towards some boys
- c. *fundu a-li-kat-i-a u-meme m-taa (Malefactive)
 technician 1SA-PST-cut-APP-FV 11-power 3-neighborhood
 the technician cut power to the neighborhood.
- d. ??wa-toto wa-li-vunj-i-a ch-ungu ma-we (Instrumental)
 2-child 2SA-PST-break-APP 7-pot 6-rock
 the children broke the pot with rocks
- e. ??wa-windaji wa-li-wind-i-a ndovu pesa (Purpose)
 2-hunter 2SA-PST-hunt-APP-FV 9elephant 10money
 the hunters hunted the elephant for money
- f. wa-teja wa-li-l-i-a ch-akula ofisi-ni (Locative)
 2-customer 2SA-PST-eat-APP-FV 7-food office-LOC
 the customers ate food in the office

The direct object precedes the applied object, only in the locative applicative (19f). In benefactive, goal and malefactive applicatives, the applied object cannot follow the direct object (19a,b,c). Instrumental and motive applicatives are extremely marginal cases (19d,e) as in the order we saw in (18d,e). Thus, these two applicative constructions exhibit problems when both objects appear in postverbal position. I discuss the particular restrictions on the instrumental and motive applicatives in Chapter 5.

⁶ All grammaticality judgments are based on the intended meaning indicated after the glosses. Other possible readings will be referred to when they are relevant to the discussion. For example, (19b) is grammatical if the goal is the milipede. But what is relevant here is "towards the boys".

Objects can be realized in one of the following four ways: (i) a DP without a clitic, (ii) a clitic together with its lexical DP (clitic doubling), (iii) a clitic without a lexical DP, and (iv) no DP and no clitic. The four are illustrated in the following examples.

Swahili

- (21) a. m-geni a-li-let-a zawadi
 1-guest 1SA-PST-bring-FV 9present
 the guest brought a present
- b. m-geni a-li-i-let-a zawadi
 1-guest 1SA-PST-bring-FV 9present
 the guest brought the present
- c. m-geni a-li-i-let-a \emptyset
 1-guest 1SA-PST-bring-FV
 the guest brought it
- d. m-geni a-li-let-a u-jumbe?
 1-guest 1SA-PST-bring-FV 11-message
 did the guest bring a message?
- ndiyo, a-li-let-a \emptyset
 yes, 1SA-PST-bring-FV
 yes, she did

The object in (21a) is not cliticized. The object is cliticized in (21b,c). Clitic doubling is illustrated in (21b). In the response in (21d), there is neither object clitic nor the object DP. The four patterns are summarized in (22) below.

- (22) a. \emptyset V DP
 b. CL V DP
 c. CL V \emptyset
 d. \emptyset V \emptyset

From these patterns of object realization, it can be seen that a null object is possible only when there is a clitic⁷. Cliticization onto the verb is not possible for objects of prepositions as the following examples illustrate.

Swahili

- (23) a. ni-li-zungumz-a na Juma
I-PST-speak-FV with Juma
I spoke with Juma
- b. *ni-li-m-zungumz-a na Juma
I-PST-1OA-speak-FV with Juma
I spoke with Juma

The object of the preposition "with" cannot be cliticized on the verb as shown in (23b).

Swahili and Ndendeule, like other Bantu languages, have a rich system of verbal prefixes. These include negation, subject agreement, tense, aspect, relative marker and object clitic. The following examples from Swahili can give the picture.

Swahili

- (24) a. a-ta-ku-nunul-i-a
1SA-FUT-you-buy-APP-FV
she will buy (something) for you
- b. a-li-cho-ku-nunul-i-a
1SA-PST-REL⁷-you-buy-APP-FV
what she bought for you
- c. ha-ta-ku-nunul-i-a
NEG1SA-FUT-you-buy-APP-FV
she will not buy (anything) for you

⁷ I will argue in the next chapter that in cases where both the clitic and object DP are missing we have VP ellipsis. The two, CL V \emptyset and \emptyset V \emptyset , behave differently and have different rules of interpretation.

The following is the prefix template of the Swahili verb. The verbs on this template are taken from (24).

(25)	Neg	SA	Tns/Asp	Rel	OA	Verb	Suffixes
a.		a	ta		ku	nunul	i-a
b.		a	li	cho	ku	nunul	i-a
c.	h	a	ta		ku	nunul	i-a

The object clitic appears adjacent to the verb root after all other prefixes. Phonologically, the entire complex is a unit, a phonological word identified by penultimate stress. However, it is evident that some morphemes in Swahili are specified for [-stress] as Batibo and Rottland (1993) argue. If such a morpheme occupies the penultimate position, another syllable is inserted to carry the stress. For example:

Swahili

- (26) a. ku-l-a
INF-eat-FV
to eat
- b. *ni-na-l-a
I-PRT-eat-FV
I am eating
- c. ni-na-ku-l-a
I-PRS-INF-eat-FV
I am eating
- d. ni-na-li-l-a
I-PRS-5OA-eat-FV
I am eating it

The present tense marker in (26b) cannot carry stress. The infinitive marker is inserted. This marker is not needed when the an object agreement occupies the penultimate position (26 d). Furthermore, there are monosyllabic words

such as *na* (and) and *ni* (be) in Swahili. Such words are generally not stressed. Thus the notion of a phonological word may not be relevant in this respect.

The question is: does this phonological word correspond to a syntactic word? The answer is no. Notice that in (25b) above, a C type element intervenes between tense/aspect and the object agreement marker. This means we have at least two independent syntactic heads.

It has been proposed that object clitics are associated with specificity, a well-known generalization for many languages (cf. Givon (1975) and Mould (1974) on Bantu; Sportiche (1993) on French and Dutch, etc; Mahajan (1991) on Hindi; Morolong and Hyman (1977) on Sesotho). The situation is slightly more complex as I will show.

Specific objects trigger obligatory object agreement as the following examples with demonstratives and proper names show.

Swahili

- (27) a. *si-ku-on-a m-tu h-uyu
 NEG-I-PST-see-FV 1-person this-1
 I didn't see this person
- b. si-ku-mw-on-a m-tu h-uyu
 NEG-I-PST-1OA-see-FV 1-person this-1
 I didn't see the person
- c. *si-ku-on-a Juma
 NEG-I-PST-see-FV Juma
 I did not see Juma
- d. si-ku-mw-on-a Juma
 NEG-I-PST-1OA-see-FV Juma
 I did not see Juma

The demonstrative makes the object very specific. The sentence which has a specific object without a clitic (27a) is ungrammatical. (27b) has a clitic and

- c. fundi a-li-i-kat-i-a mi-taa u-meme (Malefactive)
 1technician 1SA-PST-4OA-cut-APP-FV 4-neighborhood 11-power
 the technician cut power to the neighborhoods.
- d. *wa-toto wa-li-ya-vunj-i-a ma-we ch-ungu (Instrumental)
 2-child 2SA-PST-6OA-break-APP 6-rock 7-pot
 the children broke the pot with rocks
- e. *wa-windaji wa-li-zi-wind-i-a ndovu pesa (Purpose)
 2-hunter 2SA-PST-10OA-hunt-APP-FV 9elephant 10money
 the hunters hunted the elephant for money
- f. *wa-teja wa-li-pa-l-i-a ch-akula ofisi-ni (Locative)
 2-customer 2SA-PST-16OA-eat-APP-FV 7-food office-LOC
 the customers ate food in the office

This diagnostic shows that the only applied objects which can be clitic doubled are benefactives, malefactive and goals (29a,b,c).

2.2.2 Clitic Doubling of the Theme / Patient

When the object marking is reversed so that the theme/patient precedes the applied object, different results are obtained. This is shown in the following examples from Swahili.

- (30) a. *Juma a-li-ki-nunul-i-a m-toto ki-tabu (Benefactive)
 Juma 1SA-PST-7A-bring-APP-FV 1-child 7-book
 Juma bought a book for the child
- b. *m-sichana a-li-m-sukum-i-a wa-vulana jongoo (Goal)⁸
 1-girl 1SA-PST-1OA-push-APP-FV 2-boy 1- millipede
 the girl pushed a millipede towards the boys
- c. *fundu a-li-u-kat-i-a mi-taa u-meme (Malefactive)
 technician 1SA-PST-11OA-cut-APP-FV 4-neighborhood 11-power
 the technician cut power to the neighborhoods.
- d. ??wa-toto wa-li-ki-vunj-i-a ch-ungu ma-we (Instrumental)
 2-child 2SA-PST-7OA-break-APP 6-rock 7-pot
 the children broke the pot with rocks

⁸ Grammatical for the irrelevant meaning "the girl pushed boys towards the millipede".

- e. ??wa-windaji wa-li-wa-wind-i-a ndovu pesa (Motive)
 2-hunter 2SA-PST-2OA-hunt-APP-FV 2elephant 10money
 the hunters hunted the elephant for money
- f. wa-teja wa-li-ki-l-i-a ch-akula ofisi-ni (Locative)
 2-customer 2SA-PST-7OA-eat-APP-FV 7-food office-LOC
 the customers ate food in the office

The direct object cannot be cliticized or clitic doubled in benefactive, goal and malefactive applicatives. Only the theme/patient of locative applicative can be clitic doubled without problems. Clitic doubling of the direct object in instrumental and motive applicatives (30d,e) yields slightly better results (though not fully grammatical) compared to clitic doubling of the instrument or motive (29d,e). In Chapter 5, I will show that direct objects in instrumental and motive applicatives can cliticize without doubling.

The facts about clitic doubling in benefactive, goal and malefactive applicatives parallel those of dative constructions (i.e. bare double objects constructions). In dative constructions, it is the indirect object that is clitic doubled as the following examples show.

Ndendeule

- (31) a. hokolo a-ki-βa-pe1-a βa-chokolo hi-tabu
 grandpa 1SA-PST-2OA-give-FV 2-grandchildren 8-book
 grandpa gave the grandchildren books
- b. *hokolo a-ki-hi-pe1-a hi-tabu βa-chokolo
 grandpa 1SA-PST-8OA-give-FV 8-book 2-grandchildren
 grandpa gave the grandchildren books
- c. *hokolo a-ki-hi-pe1-a βa-chokolo hi-tabu
 grandpa 1SA-PST-8OA-give-FV 2-grandchildren 8-book
 grandpa gave the grandchildren books

- b. a-li-wa-let-e-a meneja wa-fanyakazi
 1SA-PST-2OA-bring-APP-FV 1manager 2-worker
 she brought a manager to the workers
- c. *a-li-m-let-e-a wa-fanyakazi meneja
 1SA-PST-1OA-bring-APP-FV 2-worker 1manager
 she brought a manager to the workers
- d. *a-li-m-let-e-a meneja wa-fanyakazi
 1SA-PST-1OA-bring-APP-FV 2-worker 1manager
 she brought a manager to the workers
- e. a-li-ki-let-e-a ki-wanda meneja
 1SA-PST-7OA-bring-APP-FV 7-factory 1manager
 she brought a manager to the factory
- f. *a-li-m-let-e-a meneja ki-wanda
 1SA-PST-1OA-bring-APP-FV 1manager 7-factory
 she brought a manager to the factory

The examples (32 a-d) were constructed so that both objects are human, but only the "workers" are the beneficiaries. In the grammatical sentences (32a,b) the clitic doubles the beneficiary. Clitic doubling of the direct object as in (32c,d) is ungrammatical. Sentences (32c,d) are grammatical with the irrelevant reading that the beneficiary is "the manager", but the reading with "the workers" as the beneficiary in these two sentences is not available. The beneficiary in (32e,f) is inanimate. When "the factory" is cliticized (32e) the sentence is grammatical, but when the theme is cliticized (32f), the sentence is ungrammatical. These facts are true for both Swahili and Ndendeule. I therefore conclude that the theme cannot be cliticized and that structural factors underly the cliticization possibilities.

However, we can sometimes see animacy effects in non-specific cases in which animate/humans may cliticize but inanimates may not cliticize. For example:

Swahili

- (33) a. si-ku-on-a motokaa
I-PSTNEG-see-FV 9car
I did not see a car
- b. *si-ku-i-on-a motokaa
I-PSTNEG-9OA-see-FV 9car
I did not see a car.
- (34) a. si-ku-on-a m-tu
I-PSTNEG-see-FV 1-person
I did not see anyone
- b. si-ku-mw-on-a m-tu
I-PSTNEG-1OA-see-FV 1-person
I did not see anyone

Example (33b) shows that you cannot cliticize an indefinite inanimate object. This is contrasted with (34b) which shows you can cliticize an indefinite human object. Bantu languages differ in the extent they exhibit animacy effects (cf. Morolong and Hyman, 1977; Wald, 1975).

The facts regarding cliticization in general and cliticization in applicatives in particular establish that syntactic properties such as the structural positions, specificity and definiteness are primary in Swahili and Ndendeule cliticization. The animacy hierarchy is secondary.

2.3. Passivization in Swahili

As in other Bantu languages, passivization in Swahili is characterized by passive morphology and DP movement. The passive verb is formed by affixing -w- before the final vowel. The logical object becomes the subject of the passive sentence. The logical subject can be expressed in a *by*-phrase. These features are shown in the following examples.

- (35) a. Shaaban Robert a-li-andik-a ki-tabu ch-a *Pambo la Lugha*
 Shaaban Robert 1SA-PST-write-FV 7-book 7-ASS *Pambo la Lugha*
 Shaaban Robert wrote *Pambo la Lugha*
- b. Ki-tabu ch-a *Pambo la Lugha* ki-li-andik-w-a na Shaaban Robert⁹
 7-book 7-ASS *Pambo la Lugha* 7SA-PST-write-PASS-FV by Shaaban Robert
Pambo la Lugha was written by Shaaban Robert.

The external argument can be expressed in a *by*-phrase or it can be an implicit argument (Roeper, 1987; Jaeggli, 1986; Kural, 1996). In constructions involving two objects, only the highest can passivize. Therefore passivization can be used to indicate which object in double object constructions is higher. I compare the applied objects with the non-applied objects. Ndendeule does not have a passive construction. All subsequent discussion on passivization will only deal with Swahili cases.

2.3.1 Passivization of the Applied Objects

The following examples reflect the judgment on sentences in which the applied object is promoted to the syntactic subject position.

Swahili

- (36) a. m-toto a-li-nunul-i-w-a ki-tabu (Benefactive)
 1-child 1SA-PST-1OA-bring-APP-PASS-FV 7-book
 The child had a book bought for him
- b. wa-vulana wa-li-sukum-i-w-a j-ongoo (Goal)
 2-boy 2SA-PST-push-APP-PASS-FV 5-millipede
 the boys had millipede pushed towards them
- c. mi-taa i-li-kat-i-w-a u-meme (Malefactive)
 4-neighborhood 4SA-PST-cut-APP-PASS-FV 11-power
 the neighborhoods were cut power to (i.e. at the expense of the neighborhood)
- d. ?ma-we ya-li-vunj-i-w-a vy-ungu (Instrumental)
 6-rock 6SA-PST-break-APP-PASS-FV 8-pot
 the rocks were used to break pots with

⁹ The preposition *na* appears in different contexts which can be equivalent to English "with", "and", "by", "from" or "to".

- e. *pesa zi-li-wind-i-w-a ndovu (Purpose)
 10money 10SA-PST--hunt-APP-PASS-FV 9elephant
 money was hunted an elephant for (elephants were hunted for money)
- f. ofisi-ni pa-li-l-i-w-a ch-akula (Locative)
 office-LOC 16SA-PST-eat-APP-PASS-FV 7-food
 in the office was eaten food

From these sentences we see that all applied objects may move to the subject position of the passive, except for instrumenta^l and purpose objects. Passivization of the instrument in this test gives a marginal sentence (36d). Promotion of the purpose phrase to the subject position results in ungrammaticality (36e).

2.3.2 Passivization of the Direct Object

The following sentences contain the same lexical items as those in (36) above. This time the non-applied object is passivized.

Swahili

- (37) a. *ki-tabu ki-li-nunul-i-w-a m-toto (Benefactive)
 7-book 7SA-PST-buy-APP-PASS-FV 1-child
 the book was bought for the child
- b. *jongoo a-li-sukum-i-w-a wa-vulana (Goal)
 1milipede 1SA-PST-push-APP-PASS-FV 2-boy
 the milipede was pushed towards the boys
- c. *u-meme u-li-kat-i-w-a mi-taa (Malefactive)
 11-electricity 11SA-PST-cut-APP-PASS-FV 4-neighborhood
 power was cut to the neighborhoods
- d. ?ch-ungu ki-li-vunj-i-w-a ma-we (Instrumental)
 7-pot 7SA-PST-break-APP-PASS-FV 6-rock
 the pot was broken with rocks
- e. ?ndovu wa-li-wind-i-w-a pesa (Motive)
 2elephant 2SA-PST-hunt-APP-PASS-FV 10money
 elephants were hunted for money

- f. ch-akula ki-li-l-i-w-a ofisi-ni (Locative)
 7-food 7SA-PST-eat-APP-PASS-FV 9office-LOC
 the food was eaten in the office

This time we have both instrumental and motive applicative passives as marginally grammatical (37b,d). The patient in locative applicative can be the subject of the passive without any problem. The patient/theme argument in benefactives, goal and malefactives may not be the subject of the passive.

It is clear that some of the applied objects (beneficiary, goal, maleficary and locative) may be passivized. These facts raise the following questions: (i) why can some applied objects passivize and not others? (ii) Why are the direct objects in benefactive, goal and malefactive applicatives unable to be passivized? (iii) Why can either the direct object or the locative passivize in locative applicatives?

2.4 Reciprocalization

The reciprocal in both Swahili and Ndendeule consists of a syntactic subject and a verb to which the reciprocal {-an-} is suffixed. Example (38) below illustrates a simple reciprocal construction in Ndendeule.

- (38) a. βa-na β-i-n-liy-a tati yw-aβe
 2-child 2SA-PRT-1OA-insult-FV 1father 1-their
 the children are insulting their father
- b. βa-na β-i-liy-an-a
 2-child 2SA-PRT-insult-REC-FV
 the children are insulting each other

There cannot be an overt object in (38b). The object interpreted as reciprocal is necessarily silent. There is only a plural subject which serves as the

antecedent. I will restrict my discussion to the question which object can receive a reciprocal interpretation? This object must obligatorily be silent.

Swahili

- (39) a. wa-geni wa-li-nunul-i-an-a zawadi (rec. = BEN)
 2-guest 2SA-PST-buy-APP-REC-FV 10present
 guests bought presents for each other
- b. wa-geni wa-li-pig-an-i-a zawadi (rec. = theme)
 2-guest 2SA-PST-hit-REC-APP-FV 10present
 guests hit each other for presents

Three remarks are in order. First, depending on the interpretation, the order of the suffixes can be APP+REC as shown in (39a), or it may be REC+APP as in (39b). Secondly, the missing/reciprocalized object can be the applied object as in (39a) or it may be the theme/patient as in (39b). Thirdly, the order of the two suffixes correlates with which argument will require reciprocal interpretation.

Objects in applicative constructions do not reciprocalize freely. Some applied objects do reciprocalize and some do not. The pattern, however, is entirely parallel to the already discussed patterns obtained from adjacency to the verb, object agreement and passivization. I provide test examples in which the applied objects reciprocalize and then themes/patients reciprocalize.

2.4.1 Reciprocal Interpretation of the Applied Object

In this set of examples, the reciprocalized (and therefore the missing) object is the applied object.

Ndendeule

- (40) a. βa-ki-kom-el-an-a mbuhi (Benefactive)
 2SA-PST-kill-APP-REC-FV 10goat
 they killed goats for each other

- b. βa-chɔŋgɔlo βa-ki-kang-il-an-a ma-ɣɔŋgɔlo (Goal)
 2-boy 2SA-PST-push-APP-REC-FV 6-milipede
 the boys pushed milipedes to each other
- c. βakiyɔmɔlelana mbiya (Malefactive)
 2SA-PST-finish-APP-REC-FV 10money
 they finished each other's money
- d. *βa-ki-hiβ-il-an-a n-dyango (Instrumental)
 2SA-PST-close-APP-REC 3-door
 they used each other to block the door
- e. *βa-ki-lek-el-an-a mi-ɣonda (Reason)
 2SA-PST-leave-APP-REC-FV 4-farm
 they left the farms because of each other

In this set of examples, I have used the APP+REC order. In this order, the beneficiary, maleficiary and goal may reciprocalize as (40a,b,c). The instrument and motive may not reciprocalize as seen in (40d,e). I could not construct any sentence in which the locative is reciprocalized.

2.4.2 Reciprocal Interpretation of the Direct Object

The order, APP + REC is simply unavailable for the reciprocation of the direct object as the following examples illustrate.

Ndendeule

- (41) a. *βa-ki-kɔm-el-an-a lu-kɔlo (Benefactive)
 2SA-PST-kill-APP-REC-FV 11-clan
 they killed each other for the benefit of the clan
- d. *βa-chɔŋgɔlo βa-ki-kang-il-an-a ma-ɣɔŋgɔlo (Goal)
 2-boy 2SA-PST-push-APP-REC-FV 6-milipede
 the boys pushed each other to the milipedes
- c. *βa-ki-hiβ-il-an-a n-dyango (Instrumental)
 2SA-PST-close-APP-REC 3-door
 they used each other to block the door
- d. *βa-ki-lek-el-an-a mi-ɣonda (Reason)
 2SA-PST-leave-APP-REC-FV 4-farm
 they left of each other because of the farms

2.5 Wh-Extraction

Baker (1988b) and Alsina and Mchombo (1990, 1993) note that there are restrictions with respect to wh-extractability of the objects in applicative constructions. Beneficiaries may not extract but instruments may extract. Baker (1988b) as well as Alsina and Mchombo (1990, 1993) dealt only with benefactive and instrumental applicatives. I systematically apply this diagnostic to a wider range of applicatives just as was done for the other diagnostics.

2.5.1 Wh-extraction of the Applied Object Without Object Agreement

In the following examples, I illustrate wh-extraction with relative clauses (wh-questions are in situ). Topicalization yields similar results. In these examples there are no object clitics. As I will discuss later (see (45a,b,c)), cliticization brings different results for the benefactive, malefactive and goal applicatives.

Swahili

- (43) a. *m-toto amba-ye wa-li-nunul-i-a zawadi (Benefactive)
 1-child REL-1 2SA-PST-buy-APP-FV 9present
 the child whom they bought a present for
- b. *sanduku amba-lo wa-li-sukum-i-a takataka (Goal)
 5-box REL-5 2SA-PST-push-APP-FV 9trash
 the box to which they pushed trash
- c. *m-taa amba-o wa-li-kat-i-a u-meme (Malefactive)
 3-neighborhood REL-3 2SA-PST-cut-APP-FV 11electricity
 the neighborhood for which they cut power
- d. ki-su amba-cho wa-li-kat-i-a mu-wa (Instrumental)
 7-knife REL-7 2SA-PST-cut-APP-FV 3-sugar cane
 the knife with which they cut sugar cane
- e. sababu amba-yo wa-li-anz-i-a u-gomvi (Motive)
 9reason REL-9 2SA-PST-start-APP-FV 14-quarrel
 the reason for which they started a quarrel

- f. u-wanja-ni amba-ko wa-li-chom-e-a nyama (Locative)
 11-ground-LOC REL-17 2SA-PST-roast-APP-FV 9meat
 the grounds at which they barbecued meat

The examples show that beneficiary, goal and maleficiary (43a, b and c respectively) may not be extracted. Instruments, motive and locative (43d, e and f respectively) may be extracted.

2.5.2 Wh-Extraction of the Direct Object Without Object Agreement

All non-applied objects can be wh-extracted, as the following examples.

Swahili

- (44) a. zawadi amba-zo wa-li-nunul-i-a wa-toto (Benefactive)
 10present REL-10 2SA-PST-buy-APP-FV 2-child
 the presents which they bought for children
- d. takataka amba-zo wa-li-sukum-i-a sanduku (Goal)
 trash REL-10 2SA-PST-push-APP-FV 5-box
 the trash which they pushed to the box
- e. ?u-meme amba-o wa-li-kat-i-a m-taa (Malefactive)
 11-electricity REL-11 2SA-PST-cut-APP-FV 3-neighborhood
 the power they cut on the neighborhood
- b. mu-wa amba-o wa-li-kat-i-a ki-su (Instrumental)
 3-sugar cane REL-3 2SA-PST-cut-APP-FV 7-knife
 the sugar cane which they cut with the knife
- f. ndovu amba-o a-li-wind-i-a pembe (Motive)
 2elephant REL-2 1SA-PST-hunt-APP-FV 10horn
 the elephants which he hunted for tusks
- c. nyama amba-yo wa-li-chom-e-a u-wanja-ni (Locative)
 9meat REL-9 2 SA-PST-roast-APP-FV 11-ground-LOC
 the meat which they barbecued in the field

It appears non-applied objects may freely be extracted, except for DO of malefactive which does not seem to yield a fully grammatical sentence. This means that, for the instrumental and locative applicatives, either object may be wh-extracted.

2.5.3 Wh-Extraction of Applied Object with Object Agreement

Extraction of the applied object in benefactive, goal and malefactive applicative is possible when the applied object is cliticized. The following examples are similar to (44a,b,c) above, but with clitic doubling of the applied object.

Swahili

- (45) a. m-toto amba-ye wa-li-m-nunul-i-a zawadi (Benefactive)
1-child REL-1 2SA-PST-1OA-buy-APP-FV 9present
the child whom they bought a present for
- b. sanduku amba-lo wa-li-li-sukum-i-a takataka (Goal)
5-box REL-5 2SA-PST-5OA-push-APP-FV 9trash
the box to which they pushed trash
- c. m-taa amba-o wa-li-u-kat-i-a u-meme (Malefactive)
3-neighborhood REL-3 2SA-PST-3OA-cut-APP-FV 11electricity
the neighborhood for which they cut power

All three constructions are grammatical. Since clitic doubling is independently ruled out for other applied objects, I will not discuss them. The facts about wh-extraction are the same in both Ndebele and Swahili. In subsequent discussions, I will cite wh-construction examples mainly from relative clause constructions (both finite and infinitival relatives) and topicalization. As a diagnostic, I will use wh-extraction without cliticization only.

So far I have shown that the applied objects behave differently depending on their interpretation. While all the applied objects seem to be licensed by the same applicative affix, the applied objects do not behave the same way. The behavior appears to be governed by the fact that the applied objects are assigned different thematic roles. Some applicatives behave in the same way with respect to the five diagnostics used. The patterns show natural

sub-classes of applicatives. What applicatives pattern together? I now turn to this question of typology.

3. A Typology of Applicatives

How individual applicative constructions fare with respect to the five diagnostic properties can be summarized in the following table.

(46) Object Properties in Applicative Constructions

		BENEF.	GOAL	MALEF.	INSTRUM	MOTIVE	LOCAT.
OBJ. ORDER	AODO	√	√	√	*	*	*
	DOAO	*	*	*	?	√	√
CLITIC.	APP. OBJ.	√	√	√	?	?	*
	DIR. OBJ.	*	*	*	?√	√	√
PASS.IVIZ.	APP. OBJ.	√	√	√	?	?	√
	DIR. OBJ.	*	*	*	?√	√	√
RECIPROC.	APP. OBJ.	√	√	√	*	*	*
	DIR. OBJ.	*	*	*	√	√	√
WH-EXTRAC	APP. OBJ.	*	*	*	√	√	√
	DIR. OBJ.	√	√	√	√	√	√

Key to Judgments

√	Grammatical
?	Marginal
*	Ungrammatical

This table summarizes data from both languages Ndendeule and Swahili. The only exception here is the passive since, as stated, Ndendeule does not have a passive.

From the foregoing, the following picture is clear:

- (a) The benefactive applicative patterns the same way as goal and malefactive. In these, the applied object linearly precedes the direct object, triggers object agreement and clitic doubling, can passivize, can be interpreted as a reciprocal and requires clitic doubling to be able to wh-extract.
- (b) The instrumental applicative patterns in many ways as motive applicative with a few minor differences found in the judgement of some sentences. Unlike benefactive, goal and malefactive, instrument and motive applied objects do not cliticize, linearly precede the direct object, get reciprocal interpretation, passivize nor do they require clitic doubling to be able to wh-extract. It is the direct object that can cliticize and receive reciprocal interpretation.
- (c) The locative applicative behaves in a pattern that is different from the preceding two. The locative argument must follow the direct object, can cliticize, can passivize and can wh-extract without clitic doubling. The direct object linearly precedes the applied object, can trigger agreement, can passivize and can wh-extract without clitic doubling.

This classification raises two questions:

- (47) a. Given the fact that all the applied objects are introduced by the same affix, how can the differences in the syntactic behavior of the objects be accounted for?
- b. How can the typology be accounted for?

This section has partially answered question (15b) which is: What are the syntactic properties of the different applied objects? From the typology

that has emerged, I propose to study the benefactive as a prototype of the type which includes benefactive, goal and malefactive (Chapter 4). Instrumental applicative will be the prototype of instrumental and motive applicatives (Chapter 5). The locatives, as we have seen, emerge in a type of its own (Chapter 6).

4. Previous Analyses

As stated in Section 2, Bantu applicatives have been studied from different perspectives. In this section, I examine the contribution made by scholars from the lexical functional approach and the structural syntactic approach. Particular attention will be paid to the answers different writers provide for the questions raised in (15) above. I state the salient features of each approach with respect to the applicative constructions, then I review their contribution pointing out the strengths and weaknesses of the different analyses.

4.1 Lexical-Functional Grammar

The study of Bantu applicatives within the lexical-functional grammar (LFG) approach has been carried out by, among others, Alsina and Mchombo (1988, 1993), Bresnan and Moshi (1990) and Harford (1993). Within this approach, the different properties of objects in applicatives are attributed to the interaction of different structures of information such as grammatical function structure and semantic role structure. In this sub-section, I outline the principles underlying the analysis of the applicatives and how these principles lead to the analysis. In the third part of this subsection, I briefly

present the important insights of work done in this framework and examine unresolved issues.

4.1.1 Principles of LFG

In this approach, the theory of grammar consists of representations of information structures (Bresnan and Moshi, 1990; Bresnan and Kanerva, 1991; Alsina and Mchombo, 1993). These include constituent structure, functional structure, semantic role structure and discourse structure. The theory provides also for mechanisms of interaction between the different structures. Each structure is represented in its own different way.

Of particular importance to the study of applicatives are functional structure and semantic role structure. The functional structure deals with the representation of the grammatical functions subject and object. Grammatical functions are decomposed into [\pm restricted], a feature having to do with whether or not the function can be assigned to specific semantic roles. Thus for example the subject function is nonrestricted because any semantic role can be assigned the subject function. The oblique object function, however, is restricted to certain semantic roles. Another feature is [\pm object], a feature having to do with the distinction of arguments as complements of transitive predicator [+object] and complements of intransitive predicators [-object].

The semantic role structure is based on the assumption that thematic roles are hierarchically arranged. Following Bresnan and Kanerva (1989), the hierarchy is as follows:

(48) agent > benefactive > goal/experiencer > instrument > patient/theme > location

It is further assumed that the roles which are lower in the hierarchy enter into a relationship with the predicator before the higher roles. Although the exact ladders of the hierarchy differ among some authors, it appears well-motivated in a number of languages (cf. Bresnan and Kanerva (1989) and works cited therein). The thematic roles have intrinsic properties such as whether or not an argument is an internal argument.

The theory also provides for a mechanism linking the semantic roles to the grammatical functions. This subtheory, known as the lexical mapping theory, provides for the interaction between the different components of the theory. How the mechanism works is exemplified in the applicative constructions.

4.1.2 Analysis of Applicatives

In LFG, the applicative morpheme triggers a morpholexical operation which takes place in the lexicon. The operation changes the argument structure of the verb by adding an otherwise oblique object as an internal argument and assigning the object a thematic role. Beneficiary, goal, malefactive, instrument, motive and locative are introduced in this way. Given the hierarchical relations of the arguments, they are classified with respect to grammatical functions. The highest argument of the verb is classified as unrestricted, that is it can be assigned the subject or object functions. The other arguments are restricted to object or oblique functions. Thus if the applicative verb has the arguments agent, beneficiary and theme, the agent is unrestricted. The beneficiary and theme must be an object or oblique.

The object properties are derived from the mapping mechanism and the classification of the arguments. For example, in Chichewa, a Bantu language

spoken in Malawi, the object order in benefactive applicatives is AO DO. In instrumental applicatives, however, both orders are possible, that is, AO DO as well as DO AO (Alsina and Mchombo, 1993). This is explained by assuming that the beneficiary is specified only as non-restricted (i.e. can be object or subject). The instrument, on the other hand, can be assigned either the non-restricted feature or restricted feature. The non-restricted feature gives the instrumental a mapping similar to the benefactive (AO DO). The restricted feature, like all thematic roles below goal, will give the alternative order, DO AO.

4.1.3 *The Contribution of LFG*

Work by Bresnan and Moshi (1990) and Harford (1993) has established many properties of objects in applicative constructions. Object order, cliticization, passivization and reciprocalization as primary object diagnostics have been used extensively within this framework.

Bresnan and Moshi (1990) show that the properties vary systematically among languages. It is noted, for example, that in some Bantu languages such as Chichewa, the benefactive exhibits the primary object properties (adjacency to the verb, cliticization and passivization) and theme/patient in benefactive applicatives does not. They called such languages *asymmetrical object* languages. In benefactive constructions of other languages such as Kichaga, either object can exhibit these properties. They called such languages *symmetrical object* languages. This led to the proposal that there is one parameter distinguishing these two languages, the Asymmetric Object Parameter.

A study of the hierarchy of thematic roles within this framework has been very enlightening. There is a lot of agreement on such a hierarchy, which is present in all theories, but the exact arrangement of the different roles has been subject to some disagreement. The important point here is that there does exist some relationship between the grammatical functions and the hierarchy.

There are two areas in which I feel a structural syntactic approach can provide further insights into the applicative constructions. These are the status of {-il-} and the process of affixation, the constituent structure of the applicative predicate and the way arguments map to structure according to the thematic hierarchy.

The applicative, it is argued, is formed by a morpholexical process which takes place in the lexicon. Alsina (1990) acknowledges some syntactic processes involved in the formation not only of applicatives, but also of causatives and passives because of the way they reflect the mirror principle of Baker (1985). The mirror principle states:

(49) Morphological derivations must directly reflect syntactic derivations (and vice versa).
(Baker, 1985:)

Alsina correctly points out that the order of passive and applicative affixes with respect to the reciprocal can cause changes in meaning or in the argument that is bound. If we assume that passive, applicative and causative formations are syntactic word formations, they should not be able to undergo lexical processes such as nominalization, reciprocalization and reduplication of the stem (all of which are presumed to be lexical processes). Passives, applicatives and causatives can nominalize, reciprocalize and reduplicate and

therefore, the argument goes, they are not syntactic word formations but must have been formed in the lexicon. However, I believe that these supposed lexical processes are in fact better understood as being entirely syntactic. Kinyalolo (1991), for example, successfully analyzes both nominalization (synthetic compounds) and reciprocalization syntactically. Thus the processes that Alsina uses as diagnostics for non-syntactic process can indeed receive a full syntactic treatment. I therefore do not accept the argument that the applicative must be formed by a morpholexical process in the lexicon. Instead, I will presuppose that applicative verbs are formed in the syntax under head movement.

With respect to constituent structure, recall the assumption within the theory that the arguments lower in the hierarchy of the thematic roles should be semantically composed first with the predicator. This suggests that the verb first composes with the locative or the patient before composing with the other arguments. This essentially implies a binary branching of the type I assumed in Chapter 1, a branching which can fully be captured in a structural syntactic approach.

4.2 The Structural-Syntactic Approach

Work by Baker (1988a, 1988b, 1990, 1992), Marantz (1984, 1993) and Hoffman (1991) on Bantu applicatives follows the structural syntactic approach that I would like to adopt. There are two points of consensus among the different authors in this approach. One is that the complex verb is formed by syntactic incorporation. Secondly, different applied objects behave differently because they appear in different structural configurations. However, the authors differ in the details of the alleged structures for the

applicatives that they propose. I will discuss work by the three authors and point out unanswered questions.

4.2.1 Baker (1988a, 1988b, 1990, 1992)

Baker (1990, 1992) identifies two types of applicatives on the basis of Chichewa: benefactives and instrumentals. In Chichewa, only the beneficiary exhibits primary object properties in benefactive applicatives. In instrumental applicatives either object may exhibit primary object properties. He further suggests that the locative applicatives belong to the benefactive type. He proposes an analysis which uses the following assumptions.

(a) Theta-theory: Benefactives, like locatives, are arguments of prepositions. They are θ -marked by the preposition, in this case the applied affix. In instrumental applicatives, both the instrument and the theme/patient are arguments of the verb. They are both θ -marked by the verb. This yields the followings structures of the two applicatives incorporating the θ -theory features.

(50) a. Benefactive

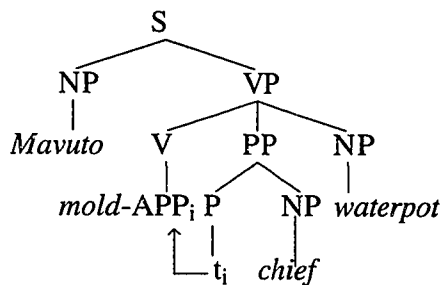

b. Instrumental

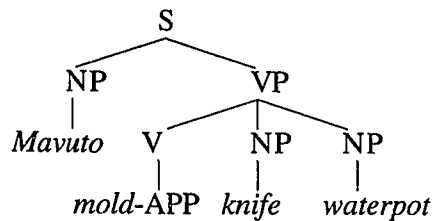

In either case, the VP has a ternary branching structure. The beneficiary in (50a) is a complement of a preposition which has moved out to incorporate onto the verb. In instrumental applicatives, both the instrument and the theme are complements of the applicative verb. The question that arises is where does the applied suffix come from here?

(b) Case Theory: Differences between the two types are derived from Case theory. Following Chomsky (1986) and Belletti (1988), Baker (1988b, 1990, 1992) structural Case is assigned under government at S-structure while inherent Case is assigned under government and θ -marking at D-structure. Structural Case is assigned to the NP adjacent to the Case assigner. This adjacency is not necessary for inherent Case assignment. Each transitive verb can assign both structural Case and inherent Case. In benefactive applicatives, the verb with its applicative suffix, assigns structural Case to the beneficiary and therefore the beneficiary is adjacent to the verb. Having moved out of the PP, the preposition cannot assign Case, neither can its trace. The theme receives inherent Case. Such a trace is not found in instrumental applicatives. Here, the verb with the applicative suffix assigns structural Case to one object (the adjacent object) and inherent Case to the other freely. Objects can thus be freely ordered.

I find this account unclear on many points and largely unsatisfactory. It is unclear how this account can be able to cover the rather complex properties of applied constructions so far established. The typology is based on classifying the applicative morpheme, in one case as a preposition and in another as a non-incorporated suffix. A further unsupported stipulation is found in his

comparison of beneficiaries and locatives. Both are regarded as arguments of prepositions, but with respect to primary object properties, locatives behave in many ways like instrumentals as seen in Section 2 above and as Alsina and Mchombo (1990) point out.

It has been argued (Kayne, 1984) that structures are binary branching, an assumption I wish to adopt. This would rule out structures such as (50). The ternary branching structure makes a particular prediction that processes affecting the VP will always show the effects on both objects in all applicative constructions. In Chapter 3, I will develop an empirical argument, based on VP ellipsis, against ternary branching structure.

Alsina and Mchombo (1990) point out similarities between instrumental and locative applicatives with respect to syntactic properties. As shown in Table (46) above, in locative instrumentals, just as in instrumental applicatives, the theme is the object adjacent to the verb, may cliticize and passivize. Baker (1992) claims this is due to Case properties of the applied objects. The instrumental object does not need structural Case and therefore it need not be adjacent to the verb. It gets inherent Case. The locative object, on the other hand, is a prepositional phrase and therefore not subject to Case theory. Therefore the similarities are coincidental.

The most important idea in Baker's analysis, however, is the idea that the typology is structural. This idea also underlies Marantz's (1993) discussion of the asymmetry between the benefactive applicatives and instrumental applicatives. Therefore, Baker answers questions (15a,b) by showing how different objects are generated in different structural positions. I have argued that Baker's answers to questions (15e,f) are inadequate.

4.2.2 Marantz (1993)

Marantz (1993), following Larson (1988), analyzes the applicative construction as a complex predicate. Marantz's analysis is mainly based on asymmetries in c-command relations¹⁰. As Marantz (1993) points out, of all the c-command tests used in Barss and Lasnik (1986), for the applicative constructions in Bantu languages only the pronominal binding by a quantified noun phrase (QNP) works. There is an asymmetry between benefactive applicatives and instrumental applicative with respect to QNP-pronoun relations. Marantz's data can be reproduced in Ndendeule benefactive applicatives.

Ndendeule¹¹

- (51) a. *na-ki-m-βek-é* *kila mu-ndu hundi hy-ake*
I-PST-1OA-put-APP-FV each 1-person 10check 10-his
I put aside for each person his checks
- b. **na-ki-m-βek-é* *hundi hy-ake kila mu-ndu*
I-PST-1OA-put-APP-FV 10check 10-his each 10-worker
I put for each worker his checks
- c. **na-ki-m-βek-é* *kila hundi mu-ndu w-ake*
I-PST-1OA-put-APP-FV each 10check 1-person 1-its
I put aside for each check its person

The possessive pronoun in (51a) is bound by a c-commanding QNP. In benefactive applicatives, only the beneficiary may bind into the theme/patient (51b). The applied object does not c-command the direct object. The

¹⁰ I will take Kayne's definition of c-command to be relevant here:
"X c-commands Y iff X and Y are categories and X excludes Y and every category that dominates X dominates Y". (Kayne, 1994:16)

¹¹ Evidently, *kila* (each) is borrowed from Arabic via Swahili. The origin of this quantifier is irrelevant here since it has been absorbed into the system.

theme/patient may not bind into the beneficiary even when it linearly precedes the beneficiary as in (51c). The QNP DP order is independently available in benefactive applicatives even when the direct object linearly precedes the beneficiary as the following examples show. Note that clitic doubling is obligatory.

Ndendeule

- (52) a. *na-ki-m-βek-e* *hundi kila mu-ndu*
 I-PST-1OA-put-APP-FV 10check each 1-person
 I put aside a check for each person
- b. *na-ki-m-βek-e* *kila mu-ndu hundi*
 I-PST-1OA-put-APP-FV each 1-person 10check
 I put aside a check for each person

In such cases the QNP does not bind into the other argument. The conclusion here is unambiguous that the beneficiary must always be higher than the direct object.

Marantz shows that instrumental applicatives behave differently with respect to QNP-pronoun relations. This holds for Swahili and Ndendeule as well. The following examples show that either object can bind into the other. Note the interesting fact here that there is no problem of having two postverbal objects if there is a QP. This contrasts with other DPs (cf. § 2.1).

Ndendeule

- (53) a. *a-ki-dindul-í* *kila n-dyango pungulu y-ake*
 1SA-PST-open-APP each 3-door 9key 9-its
 she opened each door_i with its_i key
- b. *a-ki-dindul-í* *kila pungulu n-dyango w-ake*
 1SA-PST-open-APP each 9key 3-door 3-its
 he opened with each key_i its_i door

In (53) the quantified objects precede the DP containing the pronoun. In (53a) the quantified object binds the instrument pronoun. Therefore the direct object c-commands the instrument. In (53b) the instrument binds into the direct object. Therefore the instrument c-commands the direct object in (53b). Unlike benefactive applicatives, instrumental applicatives allow either object to be a QP and bind a pronoun in the other object that it c-commands.

The order DP QP in which the QP binds into the preceding DP is excluded due to a general failure of c-command. The following examples illustrate this.

Ndendeule

- (54) b. *a-ki-dindul-í n-dyango *w-ake* kila pungulu
 1SA-PST-open-APP 3-door 3-its each 9key
 she opened its_i door with each key_i
- d. *a-ki-dindul-í pungulu *y-ake* kila n-dyango
 1SA-PST-open-APP 9key 9-its each 3-door
 he started with its_i key each car_i

The pronouns in (54) are not c-commanded by the QPs which follow them.

These facts about the asymmetry of objects in benefactive applicatives and symmetry in instrumental applicatives are true of Ndendeule and Swahili, and thus reflect Marantz's findings about Chichewa applicatives. The symmetry of instrumental applicatives, however, does not extend to locative applicatives to which I now turn.

The locative applicatives behave yet differently from the benefactive and instrumental applicatives. This can be seen in the Ndendeule sentences in (57).

Ndendeule

- (55) a. βa-ki-m-βol-e kila mu-ndu pa-kaya *p-ake*
 2SA-PST-1OA-teach-APP each 1-person 16-9home 16-his
 they taught each person at her home

- b. *βa-ki-βol-e kila pa-kaya mu-ndu w-ake
 2SA-PST-teach-APP each 16-9home 1-person 1-its
 they taught at each home its person

Only the patient may bind into the locative phrase (55a). The reverse is not possible (55b). This means only the patient can c-command the locative phrase. Note also that (55b) is not ruled out because of the order Loc DO. The order in which a quantified locative precedes a DP without binding is independently available in the following sentence.

Ndendeule

- (56) ta-ki-βek-a kila mu-ch-umba βa-γeni βa-βele
 we-PST-put-FV each 16-7-room 2-guest 2-two
 we put in each room two guests

As with instrumentals, the word order possibilities are different with distributive QPs than with non-quantified in which only the order Theme Loc is available (cf. § 2.1).

There is a further constraint on locatives in Swahili that does not hold for Ndendeule. In Ndendeule, quantification of the entire locative is possible as (56) shows. The locative in Swahili cannot be quantified. Locative phrases can be expressed as locative DPs or as PP as shown in the following examples.

Kiswahili

- (57) a. a-li-wa-fundish-i-a ofisi-ni (Loc)
 1SA-PST-2OA-teach-APP-FV 9office-LOC
 she taught them in the office
- b. a-li-wa-fundish-a katika ofisi (PP)
 1SA-PST-2OA-teach-FV in 9office
 she taught them in the office

Swahili locative DPs cannot be quantified but the object of the preposition can be quantified as shown in the following.

Kiswahili

- (58) a. *a-li-wa-fundish-i-a kila ofisi-ni
 1SA-PST-2OA-teach-APP-FV each 9office-LOC
 she taught them in each office
- b. *a-li-wa-fundish-a kila katika ofisi
 1SA-PST-2OA-teach-FV each in 9office
 she taught them in each office
- c. a-li-wa-fundish-a katika kila ofisi
 1SA-PST-2OA-teach-FV in each 9office
 she taught them in each office

I return to this point when discussing locative applicatives in Chapter 6.

This restriction on the locative makes it impossible to test the c-command effects in Swahili. I therefore rely on the Ndendeule examples in this discussion, and present the results of the QNP-pronoun relations in the following table. Possible binding is indicated by a check and obvious non-c-command configuration with an asterix. Other cases of binding failure are indicated by shading the cells. Read QAO > DO as "quantified applied object binds into the theme/patient".

(59) QNP - Pronoun Relations

	Binding	BEN	INST	LOC
a.	QAO > DO	√	√	
b.	AO < QDO	*	*	*
c.	QDO > AO		√	√
d.	DO < QAO	*	*	*
e.	QDO > PP	√	√	√
f.	DO > QPP	*	*	*

Key	
$\alpha > \beta$	α binds into β
$\alpha < \beta$	β binds into α
√	Grammatical
*	Ungrammatical
	Ruled out for independent reasons

The test by Marantz presented the judgements obtained for (59a,c).

A further important discovery that we made so far concerns the fact that the distributive quantifier phrases (DistQPs) have their own distributional properties. With instrumental applicatives two postverbal DPs are extremely marginal, but if one is a DistQP, there is no problem. With locative applicatives, the order is fixed for unquantified object and locative (DO Loc) whereas with quantified DPs, the ordering possibilities are different: V LocQP DP.

In Marantz's analysis, the beneficiary is outside the event structure which contains the verb and the theme/patient. For this reason, the beneficiary is located in the higher VP. The structure of benefactive applicatives is as shown in (60) below.

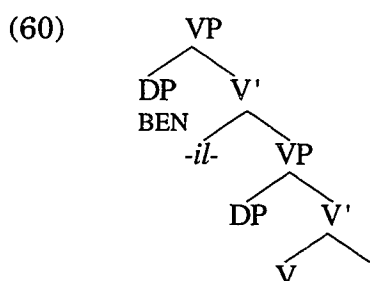

He classifies instrumental applicatives together with locative applicatives. The instrument and the locative are in the event structure containing the

direct object. The exact position of the two objects is not dictated by the event structure. That is why either object in instrumental applicative may be higher. The two alternative structures are shown in (61a,b) below.

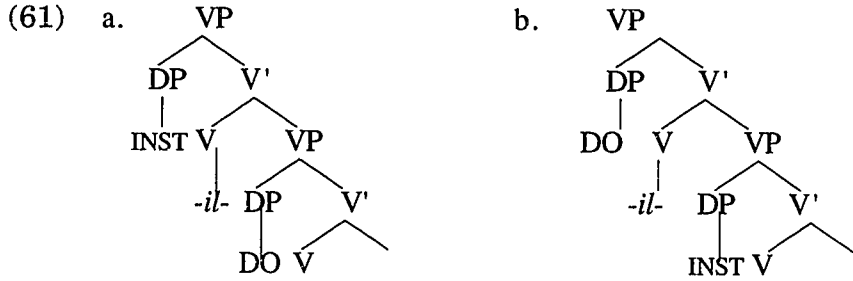

Either object in instrumental and locative applicatives can occupy either of the two DP positions. Therefore in one structure (61a) the instrument c-commands the theme/patient. In the other structure (61b) the theme/patient c-commands the instrument.

The work by Marantz, therefore, makes two very important contributions to our understanding of the applicative construction. The first concerns the c-command relations between the objects. Benefactive applicatives are asymmetrical, that is the beneficiary asymmetrically c-commands the direct object. This also explains why the beneficiary is the object which can cliticize or passivize. Marantz also shows that either object can c-command the other in instrumental and locative applicatives. This explains why either object in Chichewa instrumental and locatives can precede the other, cliticize or passivize. The second contribution is his proposal of a universal applicative structure in which there are two stacked VPs as in the following tree diagram.

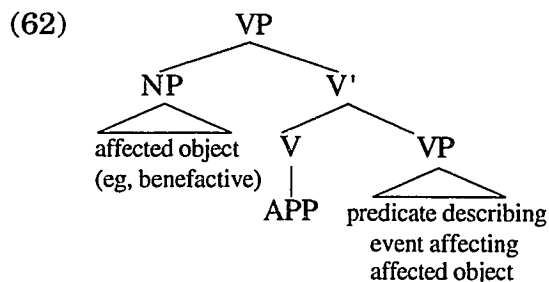

The lower VP represents the event. The applied affix is a verbal head which selects an event VP. For benefactive applicatives, the applied object occupies the Spec of the applicative projection. In instrumental and locative applicatives, the applied object can occupy either the Spec of the applicative position or the Spec of the event VP.

The proposal regarding instrumental and locative applicatives with respect to generating the applied object in either object position has a problem with how arguments are generated. The head must be in a local relationship with its arguments. An argument of the verb heading the lower VP must be within that VP. This means the theme/patient must always be generated in the lower VP. The applicative head has an applied object as one argument and a VP complement. Therefore, the applied object cannot be the complement of the verb as Marantz suggests. The explanation regarding the symmetry in instrumental and locative applicatives in Chichewa is therefore not sufficient.

Another problem is that although Marantz examines the c-command relations between the objects, no empirical evidence with respect to constituent structure is presented. The c-command relations may represent base-generated relations or derived relations. As the only evidence is from QNP-pronoun relation, one must consider the proposal made by Beghelli and Stowell (1995) that there are various QP positions to which DPs move (I

discuss this further in Chapter 5 § 2.3). Using VP ellipsis I will show in the next chapter that the constituent structure of the the applicative projection consists of stacked VPs and that the applied object is not generated in the minimal VP.

In short, Marantz (1993) answers questions (15a,b,e,f). With respect to object properties he identifies two types of applicatives: benefactive and instrumental/locative. With respect to questions (15e,f) about the applied affix, he considers the applied suffix a predicator which selects an event VP. The symmetry between objects in instrumental applicatives does not appear to have any motivation.

4.2.3 Hoffman (1991)

Hoffman discusses the applicatives mainly in terms of benefactive and non-benefactive applicatives. Drawing on findings of other researchers, she argues that the main distinction in asymmetrical object languages such as Chichewa is between the asymmetrical benefactive applicatives and the symmetrical non-benefactive applicatives. In benefactive applicatives only the applied object can precede the direct object, can cliticize and can passivize. The non-benefactive applicatives, instrumental and locative, are symmetrical, i.e. either object can precede the other, can cliticize and can passivize. Either object may passivize in Chichewa locative applicatives, while in instrumental applicatives only the instrument may passivize. Although she does not examine a wide range of applied objects, she implies the other applicatives will fall within those three types of applicatives. The typology is presented in a tree diagram below.

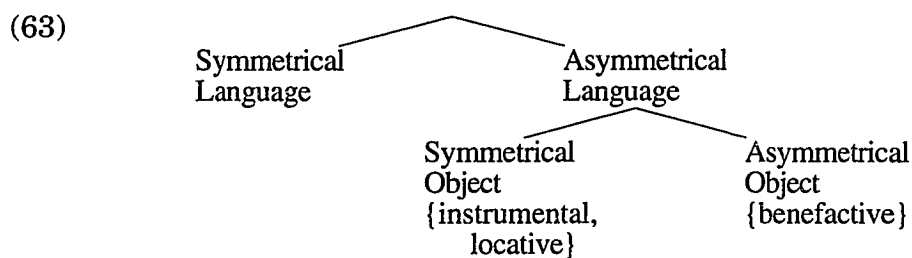

She proposes alternative structures for instrumentals and locatives to account for the three-way typology of the applicative constructions. First of all the applicative structure is a prepositional phrase in which the preposition (the applicative morpheme) relates an entity to an event. The event is basically denoted by a VP containing the verb root. The structure of the applicative predicate is shown in (64) below.

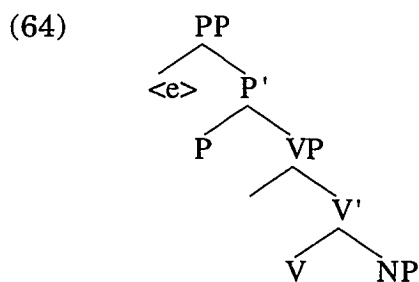

The applicative relates the entity <e>, in this case the applied object, to the event VP. The alternative object order in instrumental and locative applicatives is attributed to the general characteristic of prepositions which allow for inversion as in the case of locative inversion. The inversion of the structure shown in (64) will have the preposition and the applied object lower than the verb and its direct object.

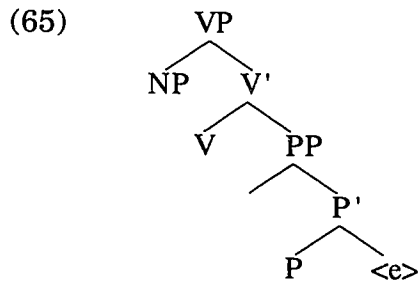

For benefactive applicatives, she assumes the preposition involved does not allow such an inversion.

This account suggests we are dealing with two different applied morphemes. One selects the event phrase and the other is selected by the verb. The motivation for such characterization is the argument structure which shows symmetry in some applicative constructions and asymmetry in others as in Chichewa. The implicit assumption of such an analysis is that all objects are found in their base-generated positions. No evidence of constituent structure is presented. Moreover, if the applied morpheme relates an entity to an event, the structure (64) should be the only structure for all applicatives. The alleged inversion shown in (65) does not show that relationship. In fact, the prepositional phrase is a complement of the V. Does this inversion occur freely? Why is there a difference between benefactive applicatives and instrumental applicatives?

However, the characterization of benefactive prepositions disallowing preposition inversion as an account of asymmetry in benefactive applicatives is erroneous. There are many languages which have symmetry in benefactive applicatives as shown by Bresnan and Moshi (1990). Bresnan and Moshi propose an asymmetrical object parameter to distinguish languages such as Swahili and Chichewa, which are asymmetrical object languages, from

Kichaga and Kinyarwanda which are symmetrical object languages. This symmetry cannot be due to the general property of the prepositions.

There is a problem of explaining the alternative object order. I assume an analysis that accounts for the verbal extension by verb incorporation. Since the applied affix is always suffixed to the verb root, a desirable account must explain this in a uniform way. Alternative structures as proposed by Hoffman require the applicatives to be generated in two different structural positions and in addition some idiosyncratic mechanism to align the morphemes for the surface structure. The general problem here is that the account on morphology fails to explain why the applied morpheme is always suffixed in the same way. Given the proposal by Kayne (1994) that head movement adjoins always to the left of the host, it implies that the V adjoins to a higher applicative head.

In a footnote Hoffman adopts Marantz's (1988) assumption that affixes specify whether they precede or follow a head. There are at least two problems with this assumption. First, it would appear in such an assumption, the order of the affixes has nothing to do with meaning since the morphemes have their specification as to what position in the verb complex they may attach. There are many examples that show that this is not the case. For example when both reciprocal and applicative morphemes are involved, alternation of the affixes corresponds to alternation in meaning as the following examples show.

Swahili

(66) a. wa-toto wa-na-pig-an-i-a fimbo
 2-child 2SA-PRT-hit-REC-APP-FV 10stick
 children are fighting for sticks

- b. wa-toto wa-na-pig-i-an-a fimbo
2-child 2SA-PRT-hit-APP-REC-FV 10stick
children are hitting each other with sticks

In these two sentences, reciprocal binding applies to the patient (viz, children). In (66a), the "sticks" are the reason for the fighting, while in (66b), they are the instruments. The position of the applied object is the same. Thus although one can specify whether an affix is prefixed or suffixed to the stem, one will need another explanation for the position of the different suffixes with respect to each other.

This brings the second problem to the fore. If every morpheme requires specification of where it must attach, an important generalization is missed. This suggests a potential problem with learning. Each affix must be acquired as idiosyncratic. An analysis that categorizes the affixes and derives their positions from a general principle is therefore preferred. Kayne's Linear Correspondence Axiom (Kayne, 1994) which suggests only left adjunction to a head is such an explanation which I will adopt in this study.

In this section I have reviewed the contribution of researchers in the lexical-functional grammar approach and the structural-syntactic approach regarding the applicative construction. I have noted that although significant advances have been made in studying the properties of the applicatives, there remain a number of important questions which still require further investigation. These include questions about the typology of applicatives since prior focus has been placed mainly on benefactive and instrumental applicatives. Another question regards the constituent structure of the applicative projection and the status of the applied suffix. And finally a major

problem is how the surface properties are derived in the different applicative constructions.

5. Summary

I have presented the basic facts regarding the applicative construction. The applicative morpheme is {-il-} in both Swahili and Ndendeule. The affixation of this morpheme to the verb adds one argument, the applied object which may be interpreted in different ways: beneficiary, goal, maleficiary, instrument, reason, location, etc. In this chapter only question (15a) has been answered regarding the properties of the objects. Some applied objects, namely, beneficiary, goal and maleficiary exhibit primary object properties (adjacency to the verb, object agreement, passivization and reciprocalization). In instrumental, motive and locative, the direct object exhibit the primary object properties. On the basis of the syntactic behavior, I classify the applicative constructions into three types whose prototypes are benefactive, instrumental and locative (cf. table of object properties (46))

The crucial questions which remain unanswered are:

- (a) How can the typology be accounted for?
- (b) What is the applicative morpheme?
- (c) Why are there only three types of applicatives?
- (d) How can the properties in (46) be accounted for?

CHAPTER THREE

VP Ellipsis in Ndendeule and Swahili Applicatives

0. Introduction

In the previous chapter, the discussion was concentrated on the syntactic properties of the different applicative constructions in Ndendeule and Swahili. In this respect, my work followed the general work on Bantu applicatives by Bresnan and Moshi (1990) for primary object properties, and Marantz (1993) for c-command relations. I systematically applied the diagnostic tests to each applied construction, and then established a finer typology and a much more complete picture of the rather complex sets of properties that must be accounted for. I have also discussed previous accounts and have pointed out that none of the previous accounts have successfully established the constituent structure of the applicative constructions.

In this chapter I investigate the constituent structure of the applicative construction in Ndendeule and Swahili using VP ellipsis. After a brief outline of the phenomenon as it is known in English in Section 1, I present constructions in Ndendeule and Swahili in which complements are missing in Section 2. I argue that although the verbs still appear on the surface, they are to be analyzed as cases of VP ellipsis. In contrast to English, the verb in Ndendeule and Swahili moves out of the VP. In Section 3, I argue against an alternative analysis which proposes to analyze the missing complement as a null object. Having justified a VP ellipsis analysis of the facts in Ndendeule and Swahili, I

apply it to the applicative construction in Section 4. I will show that VP ellipsis provides evidence for a layered VP analysis of the applicative construction.

1. VP Ellipsis

Under appropriate discourse conditions, VPs may be omitted in English. The omitted VP is recoverable within the context of discourse. For example:

- (1) a. John will buy a house and Mary will too. (omitted VP is [*buy a house*])
b. Did Mary buy a house?
c. Yes. She did. (omitted VP is [*buy a house*])

I will call the missing VP the *elliptical VP*, the remaining elements in the clause the *remnants* and the VP that determines the interpretation of the elliptical VP the *antecedent VP*.

VP ellipsis can be seen as an important diagnostic test for the constituency of predicates. By determining which elements may be omitted and which elements may not be omitted, we find evidence for the constituent structure of the VP. In example (1) above, tense is not part of the VP but a property of a projection outside the VP. Therefore, it is a remnant. The structure of the second clause of example (1b) may be presented as shown in (2) below. To simplify the analysis, I use Infl as a cover term for the functional projections Tense and Agreement and base generate *will* in Infl, as is customary.

(2) a. John will buy a house and Mary will too.

b.

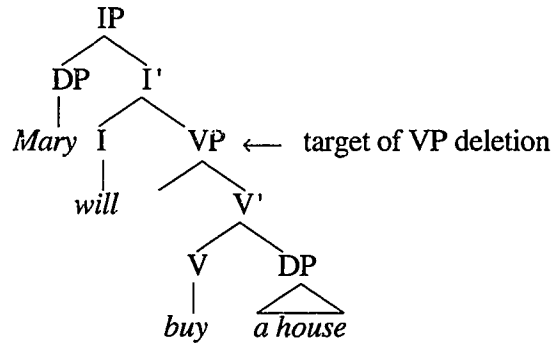

Since VP ellipsis targets the VP, the VP will be missing. Since the subject and the auxiliary verb are outside the VP, they are remnants i.e. they form an *elliptical sentence*. What happens if the main V is inflected? Tense is located outside the VP, in I. This is illustrated in (3c).

(3) a. John bought a house

b. and Mary did too

c.

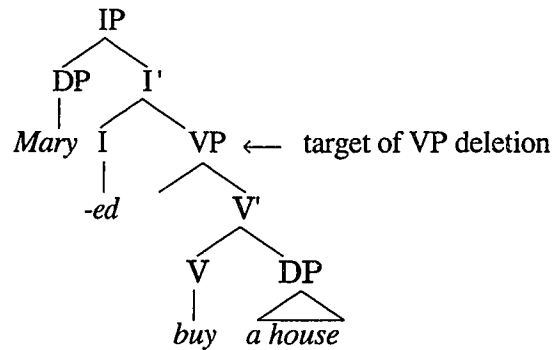

VP ellipsis takes away the V to which the tense features normally attach (3a). VP ellipsis thus leaves tense morphology stranded without a host. The auxiliary verb *do* is inserted to save the stranded tense. This is why we find *did* (*do* support) in the elliptical clause.

2. VP Ellipsis in Ndendeule and Swahili

Is VP ellipsis found in other languages? McCloskey (1991) argues that it is. In this section I will present data which show that VP ellipsis is a phenomenon which is also found in Ndendeule and Swahili. I will show that the surface form of the elliptical sentences differs from that of English, but that this difference can be reduced to an independent difference with respect to V placement.

2.1 Basic Ellipsis Facts

Both Ndendeule and Swahili have various types of elliptical structures. In the surface realization, elliptical sentences lack verb complements. In this sub-section I cite examples of elliptical sentences comprising missing object, locative, object+locative and clausal complements. In a simple declarative sentence with a simple transitive verb like (4a), it looks as if the direct object is missing from its conjunct (4b). These examples contain coordinated sentences, but as I show below, this is not the only context in which such elliptical sentences are licensed. The missing part is shown by a strikethrough.

Swahili

- (4) a. mw-alimu a-li-nunu-a ki-tabu ch-a Chomsky
I-teacher 1SA-PST-buy-FV 7-book 7-a Chomsky
the teacher bought Chomsky's book.
- b. na wa-nafunzi wa-li-nunu-a ~~ki-tabu ch-a Chomsky~~ pia.
and 2-student 2SA-PST-buy-FV ~~7-book 7-a Chomsky~~ too
and the students did too/and students bought it too¹

The direct object is missing from the second conjunct (5b). The second conjunct (5b) contains a double object verb with both a missing location and theme.

¹ I use the elliptical English form for the translation to show the parallel with the two Bantu languages.

Swahili

- (5) a. wa-geni wa-li-wek-a zawadi meza-ni
2-guest 2SA-PST-put-FV 10gift table-LOC
the guests put the gifts on the table
- b. na baba a-li-wek-a zawadi-mezani pia.
and father 1SA-PST-1OA-give-FV 10gift-table-LOC too
and father did too.

The missing part in (6b) is not an object but a locative goal.

Swahili

- (6) a. wa-zee wa - li - end-a m-ji-ni
2-old 2SA-PST-go- FV 3-town-LOC
the elders went to town
- b. na vi-jana wa-li-end-a m-ji-ni pia.
and 7-young 2SA-PST-go-FV 3-town-LOC too
and the youths did too.

The following two examples show missing clausal complements.

Swahili

- (7) a. m-kurugenzi a-li-tak-a ku-tembele-a ki-wanda ch-ote
1-director 1-PST-want-FV INF-visit-FV 7-factory 7-all
the director wanted to visit the entire factory
- b. na wa-kuu wa idara wa-li-tak-a ku-tembele-a-ki-wanda-ch-ote pia
and 2-boss of 9department 2SA-PST-want-FV INF-walk-APP 7-plant 7-all too
and heads of department did too
- (8) a. m-kurugenzi a-li-omb-a wazee wa-tembele-e ki-wanda ch-ote
1-director 1SA-PST-ask-FV them 2SA-visit-SUBJ 7-factory 7-all
the director told them to visit the entire factory
- b. lakini meneja a-li-amuru wa-tembele-e ki-wanda-ch-ote
but 1manager 1SA-PST-command 2SA-walk-APP 7-plant 7-all
but the manager commanded them.

In (7b) the missing part is an infinitival complement clause. In (8b) a subjunctive clause is missing.

The examples in this section are all coordinate structures. However, coordination is not the only context in which elliptical clauses are found. They can also occur in subordinate structures.

Swahili

- (9) a. kama mw-alimu a-ta-nunu-a ki-tabu ki-le, na-mi ni-ta-nunu-a --- pia
 if 1-teacher 1SA-FUT-buy-FV 7-book 7-that, and-me I-FUT-buy-FV -- too
 if the teacher will buy that book, I will too.
- b. ni-li-som-a vi-tabu vy-ote amba-vyo mw-alimu a-li-som-a
 I-PST-read-FV 8-book 7-all REL-8 1-teacher 1SA-PST-read-FV
 I read all the books that the teacher read

The missing part in (9a) corresponds to the complement of the if- clause. In (9b) we have a case of antecedent contained deletion. For convenience, I will mainly use examples of ellipsis in coordinated structures in the remainder of this chapter.

In sum, some part of the VP is missing in all of these elliptical sentences. However, the inflected verb is always present. This type of elliptical sentence can only occur in particular environments which are not restricted to coordinate structures.

2.2 Analysis

Here I will only sketch the analysis which is similar to an analysis proposed by McCloskey (1991) for Irish. What exactly can be missing in the elliptical sentence? It can be larger than what looks like a single constituent. Moreover, if we replace the Swahili V with "did" or an auxiliary, and if we look at the English contexts that allow for VP ellipsis we find striking similarity with VP deletion. I will therefore argue that VP ellipsis applies in these contexts and motivate this view fully below. In order to account for the

appearance of the V, I will argue that the V has raised out of the VP to some Infl element. The following tree diagram illustrates the analysis of (4b).

Swahili

- (10) a. na wa-nafunzi wa-li-nunu-a pia.
 and 2-student 2SA-PST-buy-FV too
 and students did too

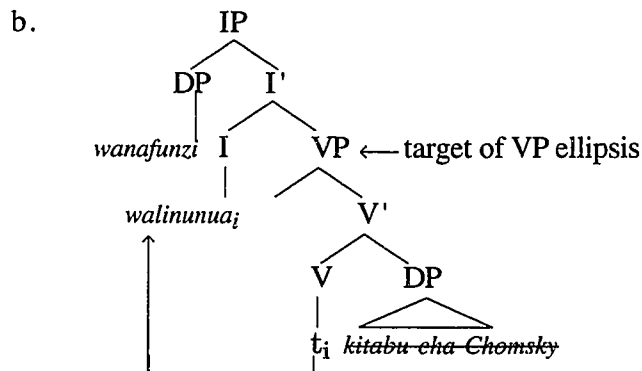

As a consequence of this analysis, the direct object has disappeared. There are no remnant features that identify the object. Assuming that the final vowel, which is in complementary distribution with the negative (in Swahili only), and the subjunctive suffix are elements in Infl, it can be said the complement of the final vowel is elided². As a result of raising to Infl, only the verb appears as a remnant. The V-raising analysis requires further justification to which I now turn.

² Examples of final vowel, negation and subjunctive are provided below.

- a. a-na-kat-a (final vowel)
 1SA-PRT-cut-FV
 she is cutting
- b. h-a-kat-i (present tense negative)
 NEG-1SA-cut-NEG
 she is not cutting
- c. ni-na-tak-a a-kat-e (subjunctive marker)
 I-PRT-want-FV 1SA-cut-SUBJ
 I want her to cut

2.3 V Movement in Ndendeule and Swahili

VP ellipsis is sometimes used as a diagnostic for verb raising (see Otani and Whitman (1991) on Japanese, Chinese and Korean; McCloskey (1991) on Irish). I present evidence independent of VP ellipsis which show that the verb in Ndendeule and Swahili raises to a higher functional projection. I draw evidence from the distribution of adverbs and from negation.

2.3.1 Adverbs

I will discuss two Swahili adverbs, *polepole* (slowly) and *kabisa* (completely), which have a different distribution. *Polepole* (slowly) can occur in the following positions.

Swahili

- (11) a. *polepole* Halima a-li-kat-a mi-wa
slowly Halima 1SA-PST-cut-FV 4-sugar cane
Slowly Halima cut sugar cane
- b. *Halima *polepole* a-li-kat-a mi-wa
Halima slowly 1SA-PST-cut-FV 4-sugar cane
Halima slowly cut sugar cane
- c. Halima a-li-kat-a mi-wa *polepole*
Halima 1SA-PST-cut-FV 4-sugar cane slowly
Halima cut sugar cane slowly
- d. *Halima a-li-kat-a *polepole* mi-wa
Halima 1SA-PST-cut-FV slowly 4-sugar cane
Halima cut slowly sugar cane

Thus, the manner adverb is only possible at the edges of the sentence (11a) and (11c). This adverb cannot occur between the subject and the verb (11b) nor between the verb and the object (11d). Its distribution is summarized in (12).

(12) *polepole* (slowly)

- a. [Adv [[DP] [V_i [VP t_i DP]]]] (as in (11a))
 b. [[[DP] [V_i [VP t_i DP]]] Adv] (as in (11c))

This adverb gives us no information about the internal structure of the clause because it occurs at the edges of the sentence. The VP adverb *kabisa* reveals more revealing in this respect. The following examples illustrate its distribution.

Swahili

- (13) a. **kabisa* Juma a-li-maliz-a kazi
 completely Juma 1SA-PST-finish-FV 9work
 Juma finished the work completely
 b. *Juma *kabisa* a-li-maliz-a kazi
 Juma completely 1SA-PST-finish-FV 9work
 Juma finished the work completely
 c. Juma a-li-maliz-a kazi *kabisa*
 Juma 1SA-PST-finish-FV 9work completely
 Juma finished the work completely
 d. Juma a-li-maliz-a *kabisa* kazi
 Juma 1SA-PST-finish-FV completely 9work
 Juma finished the work completely

These examples demonstrate that only two positions are grammatical for such adverbs: following the predicate as in (13c) or between the verb and the object as in (13d). In other words, the adverb cannot be too high. It can only be VP initial or VP final as shown in the representation of the grammatical forms shown in (14) below.

(14) *kabisa*

- a. [[DP] [[V_i [VP t_i DP]]] Adv] (as in (13c))
 b. [[DP] [V_i [Adv [VP t_i DP]]]] (as in (13d))

The seemingly non-local relationship between the head of the VP and the complement which appears after the adverb is actually a result of movement of V to a higher Infl head. The verb moves to a position higher than the adverb. The behavior of the VP adverb thus gives us a clear indication that the verb is not inside the VP, a classical argument for V-raising.

2.3.2 Negation in Ndendeule

Further evidence for V-raising is found in negation in Ndendeule. I will present the basic facts first and then argue that the verb moves over the negative. In Ndendeule one can negate the predicate or any argument. The following examples illustrate different positions of the negative word.

Ndendeule

- (15) a. mw-ana yé a-ki-tó ki-hembe
 1-child NEG 1SA-PST-take 7-knife
 it was not a child that took the knife
- b. mw-ana a-ki-tó yé ki-hembe
 1-child 1SA-PST-take NEG 7-knife
 the child did not take a knife
- c. mw-ana a-ki-tó ki-hembe yé
 1-child 1SA-PST-take 7-knife NEG
 the child took (something) not a knife
- d. mw-ana a-ki-pá yé ku-tó ki-hembe
 1-child 1SA-PST-want NEG INF-take 7-knife
 the child did not want to take a knife
- e. mw-ana a-ki-pá ku-tó yé ki-hembe
 1-child 1SA-PST-want INF-take NEG 7-knife
 the child did not want to take a knife, (but to see it)
- f. mw-ana a-ki-pá ku-tó ki-hembe yé
 1-child 1SA-PST-want INF-take 7-knife NEG
 the child wanted to take not the knife (but something else)

A detailed analysis of negation in Ndendeule is beyond the scope of this study. However, consider the negation in (15b,d,e). In (15b) the negative word appears after the verb. However, the negation must be interpreted as taking scope over the entire VP. In (15d,e) too we find the negative after the verbs. The negation in (15d) takes scope over the VP headed by "want". In (15e), the negation takes scope over the infinitival complement.

In order for the negation to have scope over the VP, it must be base-generated in a position which c-commands the VP. This means it is generated in a position higher than the verb. The fact that the verb appears before the verb must be due to movement of the verb from the VP to a position outside of the VP.

In this subsection I have argued that the verb in Ndendeule and Swahili moves out of the VP. I have presented evidence from VP adverbs in Swahili. I showed that a VP adverb appears after the verb or after the entire VP. These are positions consistent with adjunction to a VP with a raised Verb. Further evidence was presented from Ndendeule negation where I showed that the negative (which has scope over the entire VP) appears after the head of the VP. This is again consistent with V-raising analysis proposed here.

2.4 English Vs Bantu VP Ellipsis

VP ellipsis in English has been widely studied. I follow McCloskey (1991) and Otani and Whitman (1991) in comparing English VP ellipsis to VP ellipsis in Ndendeule and Swahili. Four formal properties are cited by McCloskey as characteristics of VP ellipsis in both English and Irish. These are immunity to island constraints, an auxiliary before the elided part, the availability of sloppy

identity interpretation, and antecedent-contained deletion. The differences between English and Swahili/Ndendeule and Irish are language specific mainly having to do with where the verb is spelt out, inside the VP or outside the VP.

One characteristic is the immunity of VP ellipsis to restrictions imposed by syntactic islands. These restrictions apply to movement but not to VP ellipsis. The elided part may be part of a syntactic island while the antecedent is not contained in the island as the following English sentences show.

- (16) a. one book which contains pictures and another book which doesn't ----
 b. she said she will steal the letter and I know why she would -----

In (16a) the elided VP is in a Complex NP. In (16b) the deleted VP is in a wh-island. Both are grammatical and can be translated into Swahili as follows.

Swahili

- (17) a. *ki-tabu amba-cho ki-na picha na ki-ngine amba-cho ha-ki-na.*
 7-book REL-7 7SA-have 10picture and 7-another REL-7 NEG-7SA-have
 a book which contains pictures and another book which doesn't
- b. a-li-sem-a kwamba a-ta-ib-a barua
 1SA-PST-say-FV that 1SA-FUT-steal-FV 9letter
 she said she will steal the letter
- na ni-na-ju-a kwa nini a-ta-ib-a --
 and I-PRT-know-FV for what 1SA-FUT-steal-FV
 and I know why she will

In (17a) the complex NP in question is italicized. It is the subject which is relativized. The object of the relative clause is absent because it has been deleted in VP ellipsis. The object is also absent in the wh-part of the sentence (17b).

The second property is that the deleted part must be properly governed by Infl (McCloskey, 1991; Lobeck, 1993; Zagana, 1991). In English this takes the form of an auxiliary before the deleted part as in our earlier examples repeated here as (18).

- (18) a. John bought a house and Mary did ---- too
 b. Mary won't wash the dishes but John will ---

The site of the ellipsis is indicated by ---. The property of head government always holds in Swahili and Ndendeule where we saw that the verb has moved to a higher Infl projection in all tenses.

Another property is the ambiguity between the strict interpretation of a pronoun (i.e. as a bound pronoun) and sloppy identity interpretation (i.e. freely referring pronoun). The following example in English illustrates this.

- (19) John taught his children, and Peter did too.

There are two possible interpretations for this elliptical sentence. (i) Peter taught John's children, (this is strict the interpretation). (ii) Peter taught Peter's children (this is the sloppy interpretation). In this second case the pronoun *his*, which is part of the deleted VP, is bound by *Peter*.

Analogous examples can be found in Ndendeule and Swahili, as shown below.

Ndendeule

- (20) a.. Halima_i a-ki - lem-a n-ghonda yw-ake_i
 Halima 1SA-PST-cultivate-FV 3-farm 3-her
 Halima cultivated her farm

- b. na Miche a-ki-lem-a ---- helahe
 and Miche 1SA-PST--cultivate-FV too
 and Miche cultivated Halima's farm too
 and Miche cultivated Miche's farm too.

The second conjunct has the deleted part. The possessive pronoun may be bound by Halima, the subject of the first conjunct, or it may be bound by the subject of the lower conjunct. That is to say either Miche cultivated Halima's farm or cultivated his own farm. I will return to this feature.

A final property discussed by McCloskey is antecedent-contained deletion. The deleted VP can be part of a VP. The VP which contains the deleted VP is the antecedent.

- (21) She [_{VP2} read all the same books to John [_{CP} that [I did [_{VP1} ---]]]]

We see here that VP₁ is part of VP₂. At the same time VP₂ is the antecedent of VP₁. McCloskey (1991) demonstrates that this pattern is also attested in Irish. In fact this pattern is found in Swahili and Ndendeule too. The following example from Ndendeule show this.

Ndendeule

- (22) a-ki-hemé_i [_{VP} t_i hi-tabu he-la-he
 1SA-PST-buy 8-book 8-that-8
 she bought the same books

 ku-li-duka [_{CP}hya-na-ki-hemé [_{VP} ----]]
 17-5-store 8REL-I-PST-buy
 at the store (books) (books) which I bought

Here again the same pattern of VP ellipsis found in English is demonstrated in Swahili and Ndendeule.

To sum up, I have presented four properties of VP ellipsis which McCloskey finds in both English and Irish, a language which like Ndendeule and

Swahili moves the verb out of the VP. The properties are immunity to constraints imposed by syntactic islands, government by Infl, sloppy identity interpretation and antecedent contained deletion. I have shown that all these properties are also found in Ndendeule and Swahili. Moreover, VP ellipsis is found in similar contexts. These properties support my analysis of the phenomenon in which the complement is missing and the verb appears on the surface without object agreement.

3. Alternative Analysis

A number of objections could be raised and alternative analyses could be suggested. The most serious alternative is possibly the null object analysis, which could be proposed as an alternative to VP ellipsis analysis. Instead of a VP ellipsis analysis, this alternative would analyze these constructions as null object constructions. I present five arguments against such an analysis. The arguments are based on the general distribution of null objects and object agreement, the availability of sloppy identity interpretation, the absence of double clitics, and the possible disappearance of non-object complements and idiom chunks.

3.1 Object Agreement

Both Ndendeule and Swahili allow null objects in appropriate environments, but only if object agreement is present as illustrated in the following examples.

Ndendeule

- (23) a. β a-ki-n-damukí hokolo
 2SA-PST-1OA-greet grandpa
 they greeted grandpa

- b. β a-ki-n-damukí [pro]
 2SA-PST-1OA-greet
 they greeted him
- c. * β a-ki-lamukí
 2SA-PST-greet
 they greeted me

In (23a) the object of the verb is *hokolo* (grandpa). In (23b) the object is omitted but there is an object clitic. The absence of both the object clitic and the object DP is ungrammatical (23c). In her discussion on clitics and clitic doubling in Swahili and Kikuyu, Bergvall (1986) ably demonstrates that both Bantu languages do not allow null objects without object clitics.

VP ellipsis does not involve object cliticization. Let us return to the examples of VP ellipsis already cited, but repeated here for convenience.

Swahili

- (24) a. mw-alimu a-li-nunu-a ki-tabu ch-a Chomsky
 1-teacher 1SA-PST-buy-FV 7-book 7-a Chomsky
 the teacher bought Chomsky's book
- na wa-nafunzi wa-li-nunu-a pia.
 and 2-student 2SA-PST-buy-FV too
 and students did too
- b. mama a-li-wek-a ki-kombe meza-ni
 mother 1SA-PST-put-FV 7-cup 9table-LOC
 the mother put the cup on the table
- na m-toto a-li-wek-a pia
 and 1-child 1SA-PST-put-FV too
 and the child did too

Ndendeule

- (25) Joni a-ki-hemé nyumba na Malia a-ki-hemé --- helahe
 John 1SA-PST-buy 9house and Mary 1SA-PST-buy also
 John bought a house and Mary did too

It can be seen that in all the three examples, the object is not cliticized. The null objects do not have pronominal ϕ -features. These are instances of VP

ellipsis which do not require the ϕ -features of the object. Thus null objects arising from cliticization and VP ellipsis are distributionally distinct. Therefore, whenever we have a grammatical sentence which lacks both the object and object clitic, we must find a VP antecedent in the context and the interpretation correlates with that of a deleted VP.

3.2 Lack of Double Clitics

The second argument is derived from the fact that the phenomenon I have analyzed as VP ellipsis may cause more than one object to be omitted. The following examples illustrate this.

Swahili

(26) a. m-geni a-li-nunul-i-a shule vitabu
 1-guest 1SA-PST-buy-APP-FV 10school 8-books
 guest bought books for schools

na m-kurugenzi a-li-l-~~ish-a~~ shule ~~—vitabu~~ pia
 and 1-director 1SA-PST-buy-APP-FV ~~10school 8-books~~ too
 and the director did too (buy books for the school, *buy books)

b. m-vulana a-li-l-~~ish-a~~ kondoo chumvi
 1-boy 1SA-PST-eat-CAUS-FV 2sheep 9salt
 the boy fed the sheep with salt

na mama a-li-l-~~ish-a~~ kondoo ~~chumvi~~ pia
 and mother 1SA-PST-eat-CAUS-FV ~~2sheep 9salt~~ also
 and mother did too (feed the sheep with salt, *feed sheep, *feed salt)

In (26a), a benefactive applicative construction, both the patient and the beneficiary are elided but necessarily interpreted as the same theme and beneficiary as in the first clause. In (26b), a causative construction, both the causee and the theme are omitted, but necessarily interpreted as feeding them with salt. Crucially these sentences contain no object clitics and hence cannot

be analyzed as being cases of null objects. Moreover, neither Swahili nor Ndendeule permits multiple object cliticization. Only one object can cliticize and that is the object that can be represented by a null pronoun. This further rules out the possibility of analyzing (26) as two null objects.

3.3 Deletion of Non-objects

The third argument against a null object analysis is that some elements can disappear which are not objects or DPs. Consider two such cases shown in (27) below.

Swahili

(27) a. mama a-li-tak-a ku-m-nunul-i-a m-toto vi-atu
 mother 1SA-PST-want-FV INF-1OA-buy-APP-FV 1-child 8-shoe
 mother wanted to buy the child shoes

na baba a-li-tak-a ku-m-nunul-i-a m-toto vi-atu pia
 and father 1SA-PST-want-FV INF-1OA-buy-APP-FV 1-child 8-shoe too
 and father wanted --- too

b. wa-limu wa-li-end-a shamba-ni
 2-teacher 2SA-PST-go-FV 5farm-LOC
 teachers went to the farm

na wa-nafunzi wa-li-end-a shamba-ni pia
 and 2-student 2SA-PST-go-FV 5farm-LOC too
 and their students did -- too.

In (27a) the infinitival clause complement of *taka* (want) has disappeared from the second conjunct. There is no null pronoun for such a clause. Similarly, no null pronoun can be posited for the locative complement of the second clause of (27b) because the complement is not an object.

3.4 VP Deletion and Idiom Chunks

The fourth argument concerns idiom chunks, which form idioms with specific verbs. Idiom chunks cannot be pronominalized as the following examples from English illustrate.

- (28) a. The president pays lip service to the people
b. *The president pays *it* to the people
c. The ruling party took advantage of the confusion in the opposition
d. *The ruling party took *it* of the confusion in the opposition

This same property holds in Swahili and Ndendeule. The null object pronoun is the form of pronominalization of objects in Swahili and Ndendeule. Object cliticization is the only means of identifying the silent object as the following example shows.

Swahili

- (29) a. Ni-ta-jeng-a hekalu kwa siku tatu
I-FUT-build-FV 5temple 17-a 9day 9three
I will build a temple in three days
b. Ni-ta-li-jeng-a kw-a siku tatu
I-FUT-5OA-build-FV 17-a 9day 9three
I will build it in three days

The only pronoun for the object *hekalu* is a silent object which is identified by the object clitic (29b). The identity of the object is recoverable from the ϕ -features of the clitic. These facts make one prediction: Idiom chunks cannot be cliticized since idiom chunks cannot pronominalize. Indeed this is what we find in the following examples.

Swahili

- (30) a. dada a-li-pig-a simu
sister 1SA-PST-hit-FV 9-telephone
sister called

- b. *dada a-li-*i*-pig-a
sister 1SA-PST-9OA-hit-FV
sister called
- c. Mumbi a-li-kul-a *ki-apo*
Mumbi 1SA-PST-eat-FV 7-oath
Mumbi took the oath
- d. *Mumbi a-li-*ki-l*-a
Mumbi 1SA-PST-7OA-eat-FV
Mumbi took the oath

The object idioms are in italics (30a,c). Pronominalization of the "phone" in the idiom results in an ungrammatical structure (30b). The same holds for the pronominalization of the "oath" part (30d).

Although the object idiom cannot be cliticized, it can disappear under VP ellipsis:

Swahili

- (31) a. dada a-li-pig-a *simu* na mama a-li-pig-a pia
sister 1SA-PST-hit-FV 9-telephone and mother 1SA-PST-hit-FV --- also
sister called and mother did too
- b. Mumbi a-li-kul-a *ki-apo* na Njoroge a-li-kul-a pia
Mumbi 1SA-PST-eat-FV 7-oath and Njorore 1SA-PST-eat-FV also
Mumbi took the oath and Njoroge did too

Therefore, pronominalization and the disappearance of the object under VP ellipsis are two different things. In (31) we have two examples of VP ellipsis which are not consistent with pronominalization.

3.5 Sloppy Identity Interpretation

The fifth argument against a null object analysis is the fact that sloppy identity interpretation is not available for clitic pronouns. It is available in VP ellipsis cases in a way that is similar to English as well as Irish (McCloskey, 1991) and Japanese, Chinese and Korean (Otani and Whitman, 1991). In

Section 2.3 above, I discussed sloppy identity interpretation associated with VP ellipsis. Here I show the contrast between the interpretation of null objects and sloppy identity interpretation of VP ellipsis.

Swahili

- (32) a. Juma a-li-fundish-a wa-toto w-ake
 Juma 1SA-PST-teach-FV 2-child 2-his/her
 Juma taught his children
- b. na Jamila a-li-fundish-a pia
 and Jamila 1SA-PST-teach-FV too
 and Jamila did too
 =Jamila taught Juma's children
 =Jamila taught Jamila's children
- (33) a. Juma a-li-wa-fundish-a wa-toto w-ake
 Juma 1SA-PST-2OA-teach-FV 2-child 2-his/her
 Juma taught his children
- b. na Jamila a-li-wa-fundish-a pia
 and Jamila 1SA-PST-2OA-teach-FV too
 and Jamila did too
 =Jamila taught Juma's children
 =*Jamila taught Jamila's children

The contrast here shows that a cliticized object is incompatible with sloppy identity interpretation (33b), but VP ellipsis is consistent with sloppy identity interpretation (32).

To summarize, I have presented five reasons to reject a proposal which analyzes the missing object as a null object. The first is that null objects require object agreement while the disappearance of the object under VP ellipsis does not require agreement. Secondly, in Ndendeule and Swahili only one object agreement marker, and therefore one null object, is allowed. Under VP ellipsis both objects in double object constructions such as applicatives can be deleted. Thirdly, the disappearance in VP ellipsis is not restricted to objects.

Other complements such as locatives and sentential complements may disappear. Fourthly, while objects of idiom chunks cannot be pronominalized, they can disappear under VP ellipsis. Fifthly, I have shown that sloppy identity interpretation which is a characteristic of VP ellipsis in diverse languages such as English, Portuguese, Irish, Japanese, Chinese and Korean is also found in Ndendeule and Swahili VP ellipsis cases. Therefore, the analysis of the phenomenon as VP ellipsis with V-raising covers these facts perfectly.

4. Some Differences Between English and Ndendeule/Swahili

In Section 2.3 above, I briefly looked at four properties of VP ellipsis which are found in languages as diverse as English, Irish, Ndendeule and Swahili. These are immunity of island constraint, an Infl governing the deleted VP, availability of sloppy identity interpretation and the possibility of antecedent contained deletion. There are also significant differences between VP ellipsis in English and VP ellipsis in the Bantu languages of Ndendeule and Swahili. One that has been discussed is the position of the verb. In English VP ellipsis, the verb disappears together with its complement. I argued that in Ndendeule and Swahili the verb moves out of the VP to a position which is higher. In these languages the surface form of an elliptical clause is the subject + verb which bears the tense features.

Another difference is found in the recoverability of PP adjuncts and adverbs. In the following English sentences, the prepositional phrase which disappears in VP ellipsis is recoverable, and thus part of the constituent that has been elided.

- (34) a. The oldman kept goats in the house
 b. and the son did (keep goats in the house) too

The prepositional phrase in the house is recoverable in the interpretation of the deleted VP. This, however, is not the case with Ndendeule and Swahili as we see in the following examples.

Swahili

- (35) a. wa-zee wa-li-fug-a mbuzi katika nyumba
 2-old 2SA-PST-keep animal-FV 2goat in 10house
 the old folks kept goats in the house
 b. na vijana wa-li-fug-a pia
 and 2young 2SA-PST-keep animal-FV too
 and the young people did (keep goats) too

It appears the prepositional phrase is not recoverable as the reading indicates.

With respect to adverbs, a similar difference is found. In English the adverb deleted with the VP is recoverable as illustrated in the following examples.

- (36) a. the girl cut meat slowly
 b. and the boy did (cut meat slowly) too

In Swahili and Ndendeule the reading of the adverbial is not available in the elliptical sentence. This suggests that the adverb does not form a VP constituent with the VP that undergoes ellipsis.

Swahili

- (37) a. m-toto a-li-kat-a mu-wa polepole
 1-child 1SA-PST-cut-FV 3-sugar cane slowly
 the child cut the sugar cane slowly

- b. na baba a-li-kat-a pia
 and father 1SA-PST-cut-FV too
 and the father did (cut the sugar cane ?slowly) too

Like the prepositional phrases, the adverbs cannot be deleted together with the VP.

I conclude from these facts that in English the adjuncts can remain within the VP, but in Swahili and Ndendeule the adjuncts must be outside. I have at present no insights to offer about these facts.

5. VP Ellipsis as a Diagnostic Tool on Applicative Constructions

5.1 Predictions

VP ellipsis makes interesting predictions regarding the structure of applicative constructions:

- (a) If the two objects are sisters as in Baker (1988, 1992), VP ellipsis will eliminate them together, one cannot be deleted without the other.

(38)

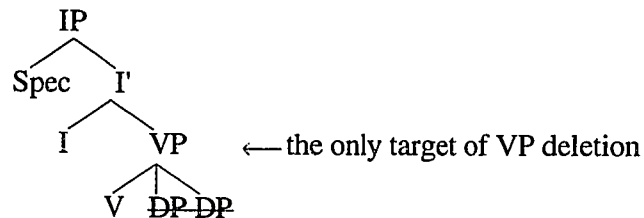

- (b) If they are in two VPs which are sisters, each object can be deleted separately.

(39)

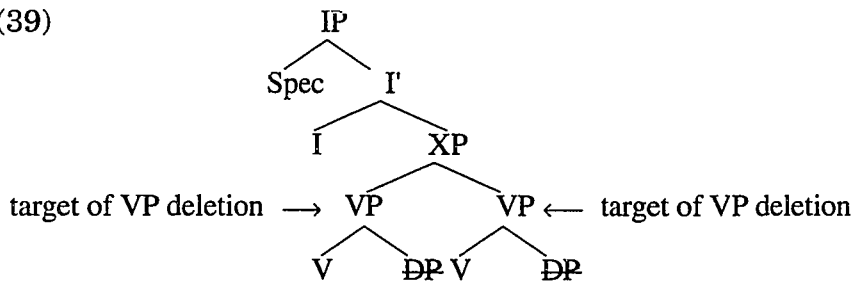

(c) If they are in stacked VPs as in Larson (1988) and Marantz (1993), then there are two targets: (i) object *a* can be deleted without *b*. (ii) *b* can only be deleted if both objects are deleted.

(40)

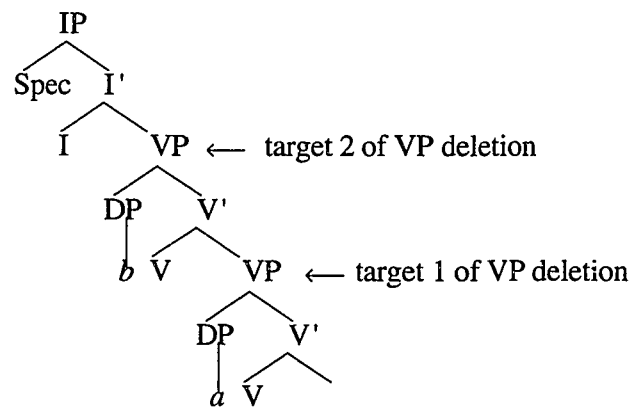

I use this diagnostic with the three types of applicatives, benefactive, instrumental and locative.

5.2 Benefactive Applicatives

Consider the following examples from Ndendeule.

Ndendeule

(41) a. n-gheni a-ki-hemel-é shuli hi-teβo
 1-guest 1SA-PST-buy-APP 9school 8-chair
 the guest bought the school some chairs

na hokolo a-ki-hemel-é shuli hi-tebo helahé
 and grandpa 1SA-PST-buy-APP 9school 8-chair too
 and grandpa bought the school some chairs

- b. na hokolo a-ki-hemel-é shuli hi-tebo helahé
 and grandpa 1SA-PST-buy-APP 9school ---- too
 and grandpa bought the school (some chairs) too
- c. *na hokolo a-ki-hemel-é shuli hi-tebo helahé
 and grandpa 1SA-PST-buy-APP ---- 8-chair too
 and grandpa bought some chairs too
- d. na hokolo a-ki-hemel-é shuli hi-tebo helahé
 and grandpa 1SA-PST-buy-APP --- too
 and grandpa did too

In (41b), only the theme disappears, and the beneficiary is a remnant. Once more the absence of a clitic for the theme means that this cannot be a null object. VP ellipsis in (41b) has targeted the VP containing the direct object. The sentence shows that there is a VP constituent which contains the V + theme, but excludes the beneficiary. This rules out the structure predicted as (38). The ungrammaticality of (41c) in which only the beneficiary is missing shows that there is no VP such that the structure is V + Beneficiary. This rules out (39). Both objects disappear in (41d) which is grammatical. These facts show that the beneficiary forms a constituent with the VP that contains the theme.

The deletion patterns show that there are two targets of VP ellipsis in the benefactive applicative construction: one is the minimal VP which contains the theme, the other VP is higher than the one containing the theme. This confirms the structure in (40). The stacked VP structure, as represented in (42b) below, supports Marantz's structure. I have put traces without identifying which verb heads which VP. Assuming local relations between heads and their arguments, I place the verb root in the lower VP since the theme is its argument. Therefore the minimal VP is headed by the verb.

Ndendeule

(42) a. *hokolo a-ki-hemele-é shuli hi-tebo helahé*
 grandpa 1SA-PST-buy-APP 9school 8-chair too
 grandpa bought chairs for some school

b.

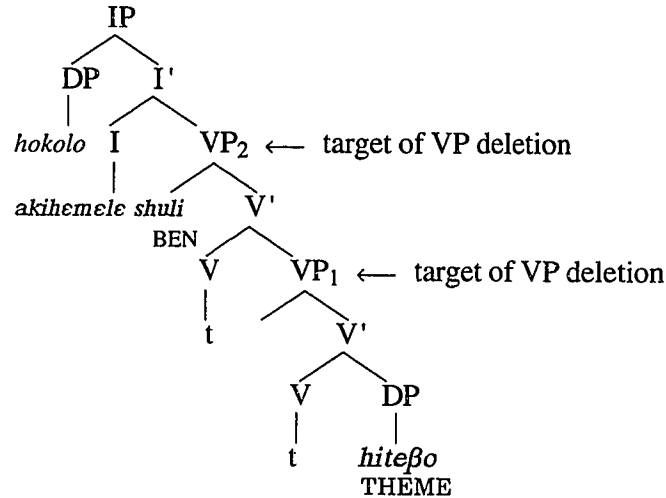

The beneficiary is an argument of the applied suffix. This would be consistent with the applicative heading the projection by subcategorizing for the applied object and a VP.

It is clear from this structure how the elliptical sentences, (41b,d) are derived. There are two VPs. (41b) is derived by VP ellipsis targeting the minimal VP₁ which contains the theme. When VP ellipsis targets VP₂, both objects disappear (41d). It is also clear how (41c) is excluded: there is no VP which contains only the beneficiary and V.

This structure of benefactive applicative is consistent with the proposal made by Marantz (1993) regarding the architecture of benefactive applicatives and c-command relations between the two objects. Marantz proposed a similar structure which accounts for why the beneficiary c-commands the theme and not vice-versa. It is also consistent with Kayne's incorporation mechanism (Kayne, 1994). The verb raises and adjoins to the left

of the governing head, the applicative head, giving the V+APP order of the morphemes.

5.3 Instrumental Applicatives

In benefactive applicatives, the applied object (the benefactive) exhibits object properties (adjacency to verb, cliticization, passivization and reciprocalization). However, in instrumental applicatives, it is the theme/patient which exhibits those object properties. Nevertheless, the pattern of VP ellipsis is the same for the instrumental applicatives and benefactive applicatives as the following examples show.

Ndendeule

- (43) a. n-haru tati a-ki-dumul-i n-kota ki-hembe,
 3-reason father 1-PST-cut-APP 3-sugar cane 7-knife
 since the father cut the sugar cane with a knife,
- na mw-ana a-ki-dumul-i n-kota ki-hembe helahe
 and 1-child 1SA-PST-cut-APP 3-sugar cane 7-knife too
 and the child cut the sugar cane with a knife too
- b. na mw-ana a-ki-dumul-i ~~n-kota~~ ki-hembe helahe
 and 1-child 1SA-PST-cut-APP ~~3-sugar cane~~ 7-knife too
 and the child did with a knife too
- c. * na mw-ana a-ki-dumul-i n-kota ~~ki-hembe~~ helahe
 and 1-child 1SA-PST-cut-APP 3-sugar cane ~~7-knife~~ too
 and the child cut the sugar cane with too
- d. na mw-ana a-ki-dumul-i ~~n-kota~~ ~~ki-hembe~~ helahe
 and 1-child 1SA-PST-cut-APP ~~3-sugar cane~~ ~~7-knife~~ too
 and the child did too

Like the benefactive applicative, the instrumental applicative allows for the VP containing the patient to delete, with the instrument as a remnant (43b). Once more, in these examples, the objects are not cliticized. Therefore, we are not dealing with null objects in these cases since null objects require a clitic

with its ϕ -features for identification. The pattern is the same for other constructions labeled instrumental such as when the applied object is an ingredient as shown below.

Ndendeule

- (44) a. li-kolo β -ana β a-ki-telek-é ma-huta
 5-vegetable 2-child 2SA-PST-cook-APP 6-oil
 the vegetables, children cooked them with oil
- b. na ne na-ki-telek-é ma-huta helahe
 and me I-PST-cook-APP 6-oil also
 and I cooked with oil too
- c. *na ne na-ki-telek-é li-kolo helahe
 and me I-PST-cook-APP 5-vegetable too
 and I cooked with vegetable too
- d. na ne na-ki-telek-é helahe
 and me I-PST-cook-APP too
 and I did too

The ingredient also behaves in the same way as the instrument with respect to VP ellipsis. It is possible to delete the VP containing the instrument together with the VP containing the patient (41d). However, there is no VP that contains only the instrument without the patient. That is why (43c) is ungrammatical. Therefore, the structure consists of stacked VPs like that of the benefactive applicative.

Any analysis of the instrumental applicative must have two VPs, with V+theme/patient as a subconstituent and VP+instrument as another constituent. One possibility is an underlying structure similar to the benefactive applicative as shown in the following phrase marker.

(45)

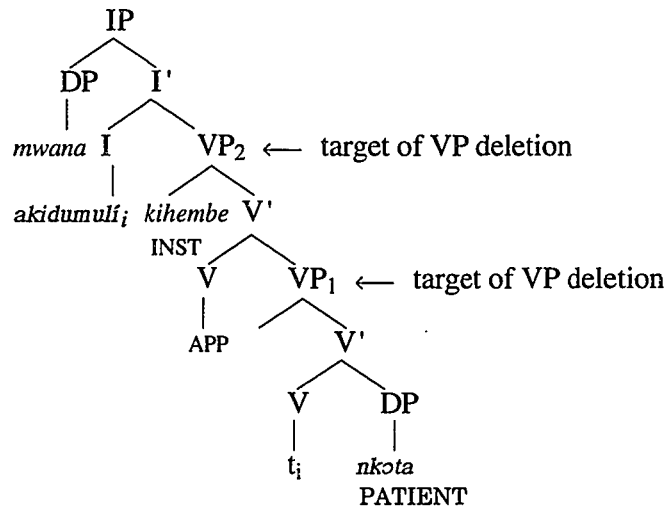

In this structure the instrument is generated in the specifier of the applicative projection in the same way as the beneficiary is generated. The V+patient is a subconstituent of the applicative projection. This structure is consistent with Kayne's incorporation account.

However, the problem that now arises is that the surface structures of benefactives and instrumentals differ considerably as we saw in Chapter 2. The instrument does not exhibit the object properties that are exhibited by the beneficiary such as adjacency to the verb, cliticization, passivization and reciprocalization. It is the direct object in instrumental applicatives which can cliticize and reciprocalize. It appears the direct object linearly precedes the instrument. The various restrictions are discussed in Chapter 5 where I also discuss the structure.

5.4 *Locative Applicatives*

In locative applicatives, the theme/patient exhibits object properties (adjacency to the verb, cliticization, passivization and reciprocalization). In a way this is similar to instrumental applicatives where the theme/patient also

exhibits primary object properties. VP deletion behaves in the same way as the other applicatives as the following examples show.

Ndendeule

(46) a. n-gheⁿi a-ki-lel-é n-hele mu-nyumba
 1-guest 1SA-PST-eat-APP
 the guest ate rice in the house

na hokolo a-ki-lel-é n-hele mu-nyumba helahe
 and grandpa 1SA-PST-eat-APP 3-rice 18-9house also
 and grandpa ate rice in the house too

b. na hokolo a-ki-lel-é ~~n-hele~~ mu-nyumba helahe
 and grandpa 1SA-PST-eat-APP --- 18-9house also
 and grandpa did -- in the house too

c. * na hokolo a-ki-lel-é n-hele ~~mu-nyumba~~ helahe
 and grandpa 1SA-PST-eat-APP 3-rice ---- also
 and grandpa ate rice in -- too

d. na hokolo a-ki-lel-é ~~n-hele mu-nyumba~~ helahe
 and grandpa 1SA-PST-eat-APP 3-rice 18-9house also
 and grandpa did -- too

In these examples, there are no object clitics. Therefore, these are instances of VP ellipsis instances and not null objects. The same pattern as in benefactive applicative and instrumental applicative emerges: the theme/patient can disappear, and both the theme/patient and the locative can disappear. The locative cannot disappear alone. In locative applicative sentences the theme object appears in the smallest VP, and the locative appears in the bigger VP. I examine various issues related to the locative applicatives in Chapter 6.

5.5 A Summary of VP Ellipsis in Applicative Constructions

The foregoing discussion has shown that although the different applied objects behave differently with respect to object properties, they all pattern in the same way with respect to VP ellipsis. The theme/patient is in the smallest

I argued against a null object alternative to VP ellipsis analysis. I have showed that null objects in Ndendeule and Swahili require a coindexed clitic with which it shares ϕ -features. I argue that a VP analysis is consistent with the availability of sloppy identity interpretation. It is also consistent with the non-availability of double clitics in Ndendeule and Swahili. Furthermore, the fact that the deleted part can be a non-object locative, infinitival complement or finite clausal complement that cannot be pronominalized supports VP ellipsis analysis. Finally, while idiom chunks cannot pronominalize, they can be deleted in VP ellipsis. This means idiom chunks cannot be null objects.

Having justified the VP ellipsis analysis, I examined the three types of applicatives with respect to VP ellipsis. In all applicatives, the VP containing the direct object is the minimal VP because it may delete without the applied object. The VP containing the applied object is the matrix VP because the applied object can only be affected if both objects are affected. With respect to the hierarchy of thematic roles, the VP ellipsis facts of applicatives indicate that all applied objects are generated between the agent and the theme/patient.

From these findings I concluded that the applicative head has two arguments. One is the applied object and the other is the VP containing the V+theme/patient. These two arguments occupy the complement and the spec positions. A number of problems are raised in the end. Given the uniform behavior of all applicatives, how can the structural differences (primary object properties) of the different applicatives be accounted for? Furthermore, how does the structure handle domain asymmetries and symmetries? How are

arguments aligned and how are they mapped to their grammatical functions.

These are the questions that are dealt with in the next 3 chapters.

CHAPTER FOUR

Benefactive Applicatives

0. Introduction

Benefactive applicatives behave differently from instrumental applicatives (cf. Chapter 2). The most notable differences between benefactive applicatives (which include benefactive, goal and malefactive) and instrumental applicatives is that object properties such as linear precedence, cliticization, passivization and reciprocalization are exhibited by the applied object in benefactive applicatives while in instrumental applicatives some of these properties are exhibited by the direct object. The other difference is the apparent domain symmetry between objects in instrumental applicatives as compared to asymmetrical objects in benefactive applicatives. In view of the proposal made in the foregoing chapters regarding (i) the asymmetry between the two objects in applicative constructions following the proposal by Marantz (1993) and (ii) constituent structure of the complex predicate, the analysis of benefactive applicatives raises very few questions.

This chapter revisits the object properties in Section 1 as part of the basic description. The review anticipates the analysis of the structure which is presented in Section 2. Before presenting the analysis, I examine the issues which any analysis of benefactive applicatives must account for and present an analysis which accounts for the various properties of benefactive applicatives. Three asymmetries are reviewed in Section 3. These are (i) the beneficiary vs. direct objects; (ii) benefactive applicatives vs instrumental

applicatives; and (iii) symmetrical object languages vs asymmetrical object languages. A brief discussion of the semantic relationship of the different applicatives included under the benefactive applicative type is included. Concluding remarks are presented in Section 5.

1. Basic Facts

The basic features that distinguish the benefactive type from the instrumental and the locative type are object properties: object order, cliticization, passivization, reciprocalization and reflexivization. These are reviewed here with two objectives: (i) to emphasize the identity of the benefactive type and to include the various applicatives which share these features; (ii) to set the stage for the questions which are investigated in this chapter.

1.1 Object Properties

In Chapter 2, I showed that applied objects in benefactive applicatives exhibit primary object properties. However, I did not go into details nor ask questions about the interaction between object order and cliticization.

1.1.1 Word Order

Judgement on the grammaticality of word order was based on examples which are repeated here.

Swahili

- (1) a. Juma a-li-nunul-i-a wa-toto vi-tabu (Benefactive)
Juma 1SA-PST-buy-APP-FV 1-child 8-book
Juma bought books for children

- b. m-sichana a-li-sukum-i-a wa-vulana j-ongoo (Goal)
 1-girl 1SA-PST-push-APP-FV 2-boy 5-milipede
 the girl pushed a milipede towards some boys
- c. fundi a-li-kat-i-a mi-taa u-meme (Malefactive)
 1-technician 1SA-PST-cut-APP-FV 4-neighborhood 11-power
 the technician cut power to some neighborhoods.

In these grammatical examples, the applied object precedes the direct object. The order of the objects in which the direct object precedes the applied object yields ungrammatical sentences as the following examples show.

Swahili

- (2) a. *Juma a-li-nunul-i-a ki-tabu wa-toto (Benefactive)
 Juma 1SA-PST-buy-APP-FV 7-book 2-child
 Juma bought children a book
- b. *m-sichana a-li-sukum-i-a j-ongoo wa-vulana (Goal)
 1-girl 1SA-PST-push-APP-FV 5-milipede 2-boy
 the girl pushed a milipede towards boys
- c. *fundu a-li-kat-i-a u-meme mi-taa (Malefactive)
 technician 1SA-PST-cut-APP-FV 11-power 4-neighborhood
 the technician cut power to neighborhoods.

Note that in both examples (1) and (2), there are no object clitics. The available reading for the applied object is indefinite non-specific. When clitics are involved, object order is not restricted.

1.1.2 Clitic Doubling

With clitic doubling the order of the object DPs is not limited. This is shown in the following sentences. First I show examples of sentences which maintain the applied object before the direct object order.

Swahili

- (3) a. Juma a-li-m-nunul-i-a m-toto ki-tabu h-iki (Benefactive)
Juma 1SA-PST-1OA-buy-APP-FV 1-child 7-book this-7
Juma bought the child this book
- b. m-sichana a-li-wa-sukum-i-a wa-vulana jongoo h-uyu (Goal)
1-girl 1SA-PST-2OA-push-APP-FV 2-boy 1milipede this-1
the girl pushed this milipede towards the boys
- c. fundi a-li-i-kat-i-a mi-taa u-meme (Malefactive)
1technician 1SA-PST-4OA-cut-APP-FV 4-neighborhood 11-power
the technician cut power to the neighborhoods.

The following examples have the same meaning as (3) above but differ in that the direct objects precede the applied objects.

Swahili

- (4) a. Juma a-li-m-nunul-i-a ki-tabu m-toto (Benefactive)
Juma 1SA-PST-1OA-buy-APP-FV 7-book 1-child
Juma bought a book for the child
- b. m-sichana a-li-wa-sukum-i-a j-ongoo wa-vulana (Direction)
1-girl 1SA-PST-2OA-push-APP-FV 5-milipede 2-boy
the girl pushed a milipede towards the boys
- c. fundi a-li-i-kat-i-a u-meme mi-taa (Malefactive)
1technician 1SA-PST-4OA-cut-APP-FV 11-power 4-neighborhood
the technician cut power to the neighborhoods.

In these examples, the applied object has clitic doubled. The order of the objects is DO AO. The reading one gets from these examples shows focus on the direct object.

Only the applied object in benefactive applicatives can be doubled. The following examples illustrate that clitic doubling of the direct object yields ungrammatical sentences.

Swahili

- (5) a. *Juma a-li-ki-nunul-i-a m-toto ki-tabu (Benefactive)
Juma 1SA-PST-7A-buy-APP-FV 1-child 7-book
Juma bought the book for the child

- b. *m-sichana a-li-m-sukum-i-a wa-vulana jongoo (Goal)
 1-girl 1SA-PST-1OA-push-APP-FV 2-boy 1-milipede
 the girl pushed the milipede towards the boys
- c. *fundi a-li-u-kat-i-a mi-taa u-meme (Malefactive)
 technician 1SA-PST-11OA-cut-APP-FV 4-neighborhood 11-power
 the technician cut power to the neighborhoods.

In these sentences the order of the objects is AO DO. But it is the direct object which is clitic doubled. The result is ungrammatical sentences. Could object order be a factor for direct object clitic doubling? The answer is negative because when the direct object is cliticized with DO AO order, the sentences are equally ungrammatical as the following examples show.

Swahili

- (6) a. *Juma a-li-ki-nunul-i-a ki-tabu m-toto (Benefactive)
 Juma 1SA-PST-7A-buy-APP-FV 7-book 1-child
 Juma bought the book for the child
- b. *m-sichana a-li-m-sukum-i-a jongoo wa-vulana (Goal)
 1-girl 1SA-PST-1OA-push-APP-FV 1-milipede 2-boy
 the girl pushed the milipede towards the boys
- c. *fundi a-li-u-kat-i-a u-meme mi-taa (Malefactive)
 technician 1SA-PST-11OA-cut-APP-FV 11-power 4-neighborhood
 the technician cut power to the neighborhoods.

From the discussion on object order and clitic doubling the following picture emerges:

- (7) a. The benefactive object is higher than the direct object.
 b. The clitic position is accessible to the higher object only.
 c. When the applied object is cliticized, the direct object can scramble.

Swahili

- (14) a. m-toto a-li-let-e-w-a zawadi na m-geni
1-child 1SA-PST-bring-APP-PASS-FV 9present by 1-guest
the child was brought a present by the guest
- b. wa-vulana wa-li-sukum-i-w-a jongoo na m-sichana
2-boy 2SA-PST-push-APP-PASS-FV 1milipede by 1-girl
the boys had the milipede pushed to them by the girl
- c. m-taa u-li-kat-i-w-a ma-ji na fundi
3-neighborhood 3SA-PST-cut-APP-PASS-FV 6-water by 1technician
the neighborhood had water supply cut from it by the technician

The direct object cannot passivize as the following set shows.

Swahili

- (15) a. *zawadi i-li-let-e-w-a m-toto na m-geni
9present 9SA-PST-bring-APP-PASS-FV 1-child by 1-guest
a present was brought the child by the guest
- b. *jongoo a-li-sukum-i-w-a wa-vulana na m-sichana
1milipede 1SA-PST-push-APP-PASS-FV 2-boy by 1-girl
the milipede was pushed to the boys by the girl
- c. *ma-ji ya-li-kat-i-w-a m-taa na fundi
6-water 6-PST-cut-APP-PASS-FV 3-neighborhood by 1technician
water supply was cut from the neighborhood by the technician

All three behave in exactly the same way: the applied object can passivize but the direct object cannot passivize.

1.1.4 Reciprocalization

In both languages only the beneficiary can be reciprocally bound by the subject as the following examples show.

Swahili

- (16) a. wa-sichana wa-li-chagul-i-an-a wa-vulana
2-girl 2SA-PST-choose-APP-REC-FV 2-boy
girls_i chose boys_j for each other_{i/*j}
- b. *wa-sichana wa-li-chagul-i-an-a wa-vulana
2-girl 2SA-PST-choose-APP-REC-FV 2-boy
girls_i chose each other_i for the boys.

1.1.5 Reflexive

Similar results are obtained when we look at reflexive binding in benefactive applicatives. The following examples test reflexivization in benefactive applicatives.

Swahili

- (17) a wa-nafunzi wa-li-ji-chagul-i-a wa-limu
2-student 2SA-PST-REF-choose-APP -FV 2-teacher
students chose teachers for themselves
- b. *wa-nafunzi wa-li-ji-chagul-i-a wa-limu
2-student 2SA-PST-REF-choose-APP -FV 2-teacher
students chose themselves for the teachers

Only the benefactive argument can reflexivize (17a). Sentence (17b) is a reflexivization of the direct object which yields an ungrammatical sentence.

All the five object properties, linear precedence, cliticization, passivization, and reciprocalization/reflexive are exhibited by the applied object only. The question that emerges is why are these features exhibited by the benefactive exclusively? I have already argued that with respect to cliticization, the determining factor is structural. It remains to be seen how the other properties are derived.

2. Benefactive Applicative Structure

This section examines the properties of benefactive applicatives in light of the applicative structure proposed earlier in Chapter 3. The analysis must also be able to answer other questions.

2.1 Issues

Any analysis of the applicative must adequately address at the least the following properties of benefactive applicatives:

- (18) a. VP ellipsis facts indicate that the Verb + DO form the smallest VP. This minimal predicate is a constituent of a bigger VP which contains the applied object also.
- b. The applied affix always appears after the verb.
- c. Object properties discussed in the preceding section show the beneficiary precedes the direct object, can cliticize, passivize, reciprocalize and reflexivize. The direct object never exhibits those features in Ndendeule and Swahili.
- d. Wh-extraction facts show that the direct object can be wh-moved. But the applied object can wh-move only when the applied object is cliticized.
- e. With distributive quantifier phrases (DistQP), only the benefactive can bind into the direct object. The direct object cannot bind into the benefactive.
- e. The analysis of the benefactive applicatives should show how the benefactive differs from instrumental applicatives as discussed in the previous chapter.
- f. The analysis of the Ndendeule and Swahili facts should shed some light on the contrast between these languages and other languages called symmetrical object languages in which the object properties are exhibited by both the applied object and the direct object (Bresnan and Moshi, 1990).

I will address these issues after outlining the analysis which is taken from the VP ellipsis chapter.

2.2 The Applicative Predicate

As discussed in Chapter 2, Marantz (1993) analyzed the applicatives as complex predicates in which the applied morpheme is the head with the event VP as its complement. The structure is repeated here in (19).

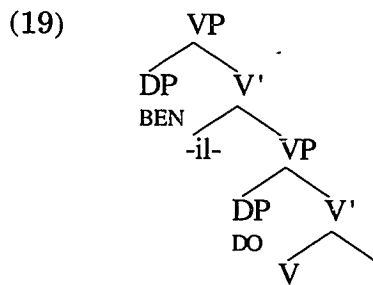

This proposal is consistent with VP ellipsis. The VP ellipsis test showed that there are two predicates. The minimal predicate contains the direct object and the higher predicate contains the applied object and minimal predicates. The two VPs of (19) are the targets of VP ellipsis as shown below.

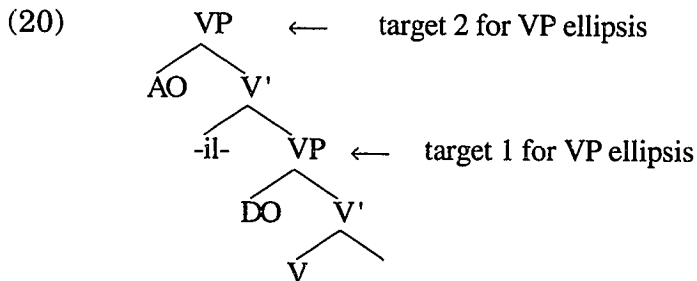

This structure is also consistent with the verb incorporation account which I already discussed in Chapter 4. With respect to issues listed above as (18a and b), this account is sufficient.

2.3 Explaining the Object Properties

2.3.1 The Order of Full DPs

I make use of sentences already cited above as (1), repeated here as (21). The point of the two sentences is to show what the positions of the arguments are when we have full DPs.

Swahili

- (21) a. Juma a-li-nunul-i-a wa-toto ki-tabu
 Juma 1SA-PST-buy-APP-FV 1-child 7-book
 Juma bought children a book
- b. *Juma a-li-nunul-i-a ki-tabu wa-toto
 Juma 1SA-PST-buy-APP-FV 7-book 2-child
 Juma bought children a book

From the sentences in (21a) we get the following patterns.

- (22) a. Subj \emptyset V-APP AO DO
- b. *Subj \emptyset V-APP DO AO

The two objects appear in positions which reflect their base-generated structural positions in which the applied object is higher and linearly precedes the direct object.

Since both objects are licensed in postverbal positions, there are two licensing positions. If we assume that these objects are licensed in the Spec of AGROPs, we will have to assume two AGROPs, one for the benefactive and

the other for the direct object. The following structure shows the object licensing positions.

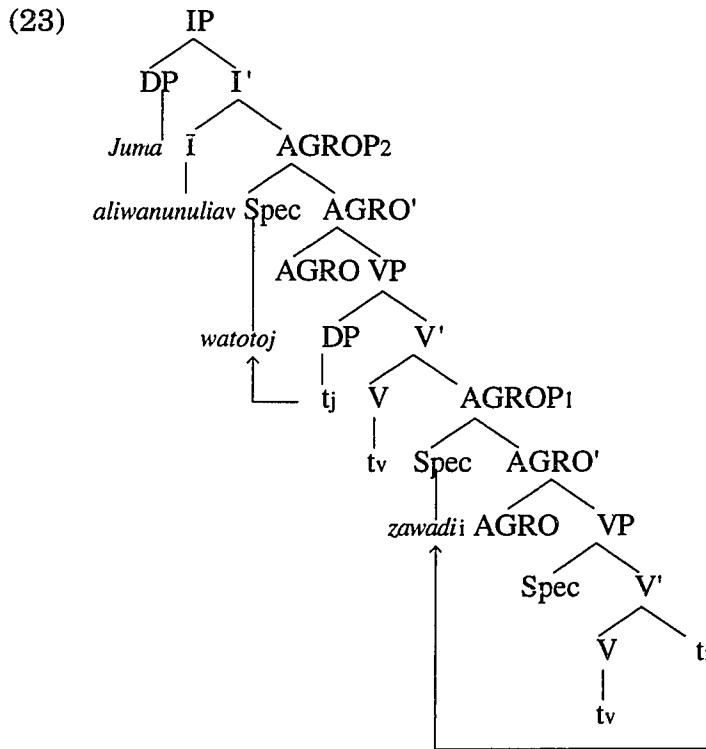

The Spec of the lower AGROP₁ licenses the direct object from the smallest VP, and the Spec of AGROP₂ licenses the applied object. This derivation accounts for the AO DO order that we find in benefactive applicatives without cliticization.

2.3.2 Cliticization

The pattern obtained from cliticization is shown in the following way:

- (24) a. Subj CL-AO V DO
 b. *Subj CL-DO V AO

If we maintain the assumption that the clitic position is higher than the predicate, then we can see that the highest object moves to the clitic position as the following derivation shows.

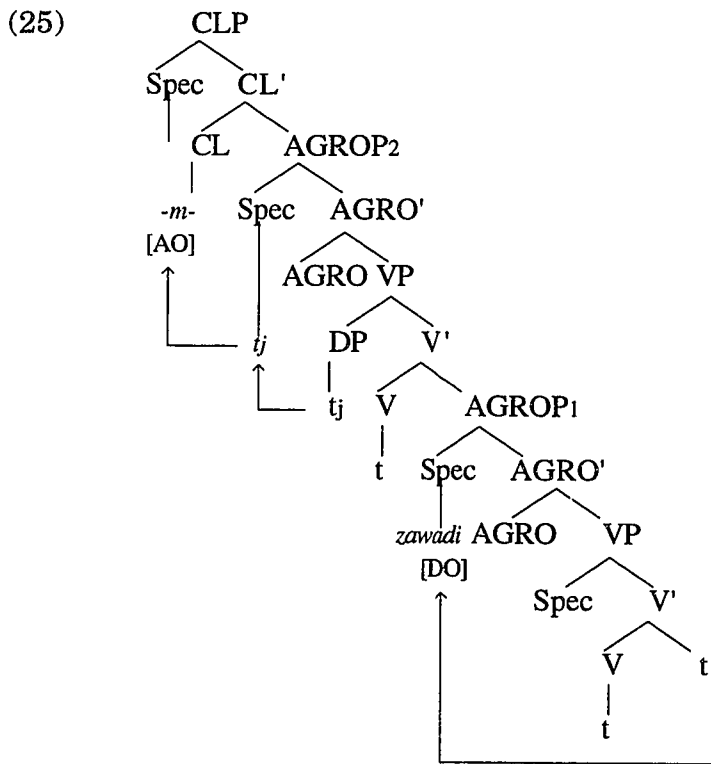

I have abbreviated the movement of the applied object to the Spec of the Clitic phrase triggering the ϕ -features on the clitic head under Spec-Head agreement relation.

2.3.3 Clitic Doubling

The applied object is capable of triggering cliticization as the following examples show.

Swahili

- (26) a. Juma a-li-m-nunul-i-a m-toto ki-tabu
Juma 1SA-PST-IOA-buy-APP-FV 1-child 7-book
Juma bought the child a book
- b. Juma a-li-m-nunul-i-a ki-tabu m-toto
Juma 1SA-PST-IOA-buy-APP-FV 7-book 1-child
Juma bought the child a book
- c. *Juma a-li-ki-nunul-i-a m-toto ki-tabu
Juma 1SA-PST-7A-buy-APP-FV 1-child 7-book
Juma bought the child a book
- d. *Juma a-li-ki-nunul-i-a ki-tabu m-toto
Juma 1SA-PST-7A-buy-APP-FV 7-book 1-child
Juma bought the child a book

The examples show that with clitic doubling, the order of the objects does not appear to be constrained. The applied object precedes the direct object in (26a) and follows the direct object in (26b).

This raises the question why object order is strict in non-clitic construction and free in clitic-doubling. Secondly, where is the doubled DP? The answer must lie in the nature of clitic doubling. If the clitic becomes overt by moving the cliticized object to the Spec of the clitic, how do we get the doubled DP? Sentence (26b) contrasts with (26a) because of the focus on "book". The order of objects in (26a) provides neutral focus. This order is consistent with base-generated object order. The order in (26b) is derived by moving the direct object to a higher position. This position must be higher than the position at which the applied object is licensed.

2.3.4 Reflexivization and Reciprocalization

The reflexive affix is found in the same position as the clitic. But unlike clitics, there is no doubling for the reflexive. Throughout the applicative

paradigm, any object that cliticizes can reflexivize also. I will therefore assume that the the subject binds a reflexive in the clitic position.

Reciprocals are different morphologically and syntactically. Unlike clitics and reflexives, the reciprocal affix is suffixed to the verb. The same argument that can reflexivize can also reciprocalize. A discussion of the morphosyntax of the reciprocal is beyond the scope of this study. What is important here is the relationship between the subject and the bound argument. Reflexive binding falls under Principle A of the Binding Theory which states:

(27) Binding Theory

An anaphor must be bound in a local domain.

(Chomsky, 1986a; Chomsky and Lasnik, 1991)

The local domain, also known as the governing category is defined by Chomsky and Lasnik (1991):

- (28) The governing category for α is the minimal CFC which contains α and a governor of α and in which α 's Binding condition could in principle be satisfied.

Given the Binding Principle, we can see how reciprocalization or reflexivization of the direct object is a violation.

Consider the structure of the benefactive applicative repeated here as (29).

Ndendeule

- (29) a. hokolo a-ki-hemel-é shuli hi-tebo helahé
grandpa 1SA-PST-buy-APP 9school 8-chair too
grandpa bought the school chair

b.

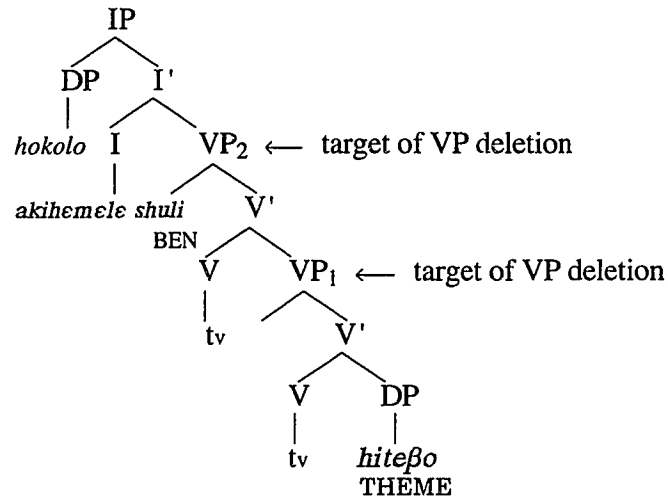

In this structure the direct object has the benefactive as its potential binder. This is the domain in which it can be bound. The local domain for the benefactive will include the subject of the sentence. Hence the binding. Reflexivizing the direct object would violate Principle A.

2.3.5 *Wh-movement*

It has often been claimed that *wh*-extraction of the benefactive is not possible (Alsina and Mchombo, 1990; Baker, 1992). This is true only up to a point. In the following set of examples, I show cases in which the beneficiary cannot be extracted and cases in which the beneficiary can be extracted. I illustrate this in infinitival relatives (for an analysis of infinitival relatives, see Chapter 5, § 1.1.1.1. The same patterns hold in finite *wh*-structures such as topicalization and finite relative clauses).

Swahili

- (30) a. *wa-toto w-a ku-nunul-i-a zawadi
 2-child 2-a INF-buy-APP-FV 10present
 children to buy presents for

- b. wa-toto w-a ku-wa-nunul-i-a zawadi
 2-child 2-a INF-2OA-buy-APP-FV 10present
 children to buy presents for
- c. *wa-toto w-a ku-zi-nunul-i-a zawadi
 2-child 2-a INF-10OA-buy-APP-FV 10present
 children to buy presents for

Example (30a) shows the extraction of the beneficiary without clitic doubling which is ungrammatical. In (30b), however, the clitic doubles the extracted beneficiary and the result is a grammatical sentence. We can generalize this in the following way:

(31) A beneficiary can be wh-extracted only if it is cliticized.

Thus, all cases which illustrate the inability of the beneficiary to wh-extract involve a violation of this generalization. (30a) above is such a violation. (30c) exhibits two violations: first the beneficiary is not cliticized and secondly direct object cliticization which, as we saw earlier, is ungrammatical for independent reasons.

Wh-extraction of the direct object, however, is different as the following examples show.

Swahili

- (32) a. zawadi z-a ku-nunul-i-a wa-toto
 10present 10-a INF-buy-APP-FV 2-child
 presents to buy for the children
- b. *zawadi z-a ku-zi-nunul-i-a wa-toto
 10present 10-a INF-10OA-buy-APP-FV 2-child
 presents to buy for the children
- c. zawadi z-a ku-wa-nunul-i-a wa-toto
 10present 10-a INF-2OA-buy-APP-FV 2-child
 presents to buy for the children

Extraction of the direct object without any cliticization is grammatical (32a), so is extraction with cliticization of the beneficiary (32c) as we saw before. The second example (32b) is ungrammatical because of the cliticization of the direct object. The facts about wh-extraction in benefactive applicatives raise the question: Why does the extraction of the beneficiary depend on cliticization?

2.3.6 Distributive Quantifiers

The asymmetry between the applied object and the direct object is shown very clearly in pronominal binding involving Distributive Quantifiers. The following examples illustrate this.

Swahili

- (33) a. Ni-li-m-wek-e-a kila m-fanyakazi hundi z-ake
 I-PST-1OA-put-APP-FV each 1-worker 10check 10-his
 I put aside for each worker_i his_i checks
- b. Ni-li-m-wek-e-a hundi z-ake kila m-fanyakazi
 I-PST-1OA-put-APP-FV 10check 10-his each 10-worker
 I put his_i checks for each worker_i;
 *I put aside for each worker_i his_i checks⁴
- c. *ni-li-m-wek-e-a kila hundi m-fanyakazi w-ake
 I-PST-1OA-put aside-APP-FV each 9check 1-worker 1-its
 I put aside each check_i for its_i worker
- d. *ni-li-m-wek-e-a m-fanyakazi w-ake kila hundi
 I-PST-1OA-put aside-APP-FV 1-worker 1-its each 9check
 I put aside for its_i worker each check_i

In these examples, the applied object is cliticized. In (33a) the QP precedes the DO into which it binds. This is the only grammatical sentence. In § 3.3, I suggested that once the beneficiary is cliticized, the direct object can raise to a

⁴ This interpretation is not possible.

focus position. Example (33b) shows a reverse of the order we find in (33a), namely, the direct object into which the beneficiary binds precedes the QP beneficiary, the binder. This yields an ungrammatical sentence. The other two, (33c) and (33d) where quantified direct objects bind into the applied objects are ungrammatical. Sentence (33d) can be grammatical with the reading "I put aside for her worker each check". That is, this order is possible independent of binding. The patterns are shown below.

- (34) a. Subj CL-AO_i V_{APP} QAO_i DO_[i]
 b. *Subj CL-AO_i V_{APP} DO_[i] QAO_i
 c. *Subj CL-AO_i V_{APP} QDO_j AO_[i]
 d. *Subj CL-AO_i V_{APP} AO_[i] QDO_j

One interesting fact is that the quantified applied object triggers object agreement. Is it possible to have a similar structure without cliticization? The answer is no. Consider the following examples:

Swahili

- (35) a. *Ni-li-wek-e-a kila m-fanyakazi hundi z-ake
 I-PST-put-APP-FV each 1-worker 10check 10-his
 I put aside for each worker_i his_i checks
 b. *Ni-li-wek-e-a hundi z-ake kila m-fanyakazi
 I-PST-put-APP-FV 10check 10-his each 10-worker
 I put his_i checks for each worker_i
 I put aside for each worker_i his_i checks

These sentences are counterparts to the grammatical sentences (33a,b) above. These two examples show that like wh-movement, movement to DistQP must also go through the clitic position.

Indeed even *wh-in-situ* requires the clitic if the benefactive is the *wh*-phrase. In both Ndendeule and Swahili, *wh*-questions have the *wh*-phrase *in-situ*. Consider now the grammatical sentence without an object clitic which we cited at the beginning of this chapter as (1a) and compare it with its *wh*-question parallel.

Swahili

- (36) a. Juma a-li-nunul-i-a wa-toto vi-tabu
 Juma 1SA-PST-buy-APP-FV 1-child 8-book
 Juma bought books for children
- b. *Juma a-li-nunul-i-a nani ki-tabu
 Juma 1SA-PST-buy-APP-FV what 7-book
 Who did Juma buy the book for
- c. Juma a-li-m-nunul-i-a nani ki-tabu
 Juma 1SA-PST-IOA-buy-APP-FV what 7-book
 Who did Juma buy the book for?
- d. *Juma a-li-nunul-i-a wa-toto nini
 Juma 1SA-PST-buy-APP-FV 2-child what
 What did Juma buy for the children?
- e. Juma a-li-nunul-i-a nini wa-toto
 Juma 1SA-PST-buy-APP-FV what 2-child
 What did Juma buy for children?

In (36b) the benefactive is a *wh*-phrase without cliticization. It yields an ungrammatical sentence. When the applied object is cliticized we get a grammatical sentence (36c). Note the contrast between (36d) and (36e) where the order of the objects seems to be significant in that the *wh*-phrase must precede the non-*wh*-object.

This problem needs more work. The only insight I offer now is that the necessity for cliticization appears to link together DistQPs and *wh*-phrases,

whether they appear in-situ or not. Both the wh-phrase and DistQP of the benefactive require cliticization.

In this section, I have considered argument alignment in benefactive applicatives in four different structures: non-cliticized full DPs, cliticization, wh-extraction possibilities, and distributive quantifiers. I have shown that the applied object is adjacent to the verb in non-cliticized constructions. It is the only object that cliticizes, raises to the distributive quantifier, and binds into the direct object. These features are easily attributable to the fact that the applied object is generated higher than the direct object. With respect to wh-construction, only the direct object can wh-move in non-clitic constructions. The applied object can only wh-move if it goes through the clitic position.

3. Asymmetries

With respect to the object properties Bantu languages do not behave the same way (Bresnan and Moshi, 1991; Alsina and Mchombo, 1990; Baker, 1992). The data in this study are from Swahili and Ndendeule which have similar object properties. But there exist a number of interesting asymmetries both within each language and between languages, that the analysis must account for.

3.1 Object Asymmetry

In benefactive applicatives, the beneficiary exhibits object properties. I showed that in the cases where there is no cliticization, the applied object precedes the direct object. This reflects the base-generated structure in which the beneficiary asymmetrically c-commands the direct object and this is

translated into linear precedence. Cliticization appears to apply to the highest DP a feature which is also true for passivization. I will assume that in both cases there is movement to a higher position (see Sportiche (1993) and Mahajan (1994) on movement to a clitic position; Kural (1996), Li (1990), Jaeggli (1986) and Baker, Johnson and Roberts (1991) on passivization). I will regard these positions as specifiers of some functional projections (XP). The following phrase marker shows the movement of the DP from the Spec of the applicative projection.

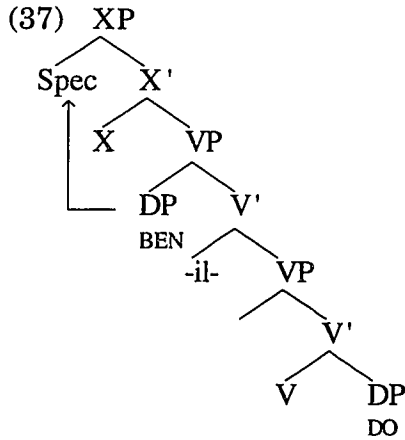

The question that arises here is why the direct object cannot move over the applied object in benefactive applicatives. It appears there is a locality constraint involved. Recall that in instrumental applicatives, the direct object can only move to the Spec of the DistQP or clitic position after the lower VP moves to a Spec position higher than the applied object. This allows the direct object to be closer to the clitic or to the DistQP. The object can only make the shortest move possible. In a structure such as (37), the applied object is closer to the XP. It is the object that can make the shortest move.

The question now becomes, why does benefactive applicative disallow a movement of the lower VP similar to that which occurs in instrumental applicatives? Although I do not provide a definitive answer, I suggest that the complexity of the instrumental applicative forces some movement which cannot be found in benefactive applicatives. Further work is required to determine what mechanism is responsible for this difference.

3.2 Symmetrical Object Languages

In their study of object properties of applicatives, Bresnan and Moshi (1990) classified Bantu languages into two types: (i) symmetrical object languages in which the applied object and the direct object exhibit object properties; (ii) asymmetrical object languages in which only one of the two objects exhibits primary object properties. Symmetrical object languages include Kichaga, Kinyarwanda and Siswati. Asymmetrical object languages include Chichewa, Swahili and Ndendeule. The question that arises is how can this asymmetry between Bantu languages be explained? It is only natural to expect that the analysis presented here should shed some light on this question. Examining applicatives in the various languages is beyond the present study. However, I will examine some points which I believe are very revealing with respect to the nature of the asymmetries. There are two important points which need to be considered.

The first one is that in all asymmetrical object languages, the beneficiary exhibits object properties. Therefore in all languages (whether symmetrical or asymmetrical), the beneficiary exhibits object properties. In symmetrical object languages, the direct object also can exhibit the object

reflexive binding, the subject can only bind the applied object. How can these properties be derived from the applicative structure proposed earlier?

3.3 Benefactive-Instrumental Asymmetry

From the previous discussion, the distinction between benefactive applicative and instrumental applicatives, hardly examined in previous studies on asymmetry (the notable exception being Baker (1992) and Marantz (1993)), is fundamental. The phenomenon known as symmetrical object languages refers to object properties in benefactive applicatives. Asymmetrical object languages such as Chichewa exhibit asymmetry in benefactive applicatives but symmetry in instrumental applicatives (Baker, 1992).

I have argued that the differences between the two applicative types are derived from their base structure configurations. Although both exhibit stacked VPs, the instrumental applicative construction has a more complex complement of the applicative head. I will discuss the instrumental applicative structure in the next chapter.

4. Benefactive Applicative Type

Using object properties, I showed that benefactive applicatives, goal applicatives and malefactive applicatives behave in the same way. I argued that the applied objects in these applicatives are generated in the same way. In subsequent discussions I have used the benefactive applicative as the proto-type of all these applicatives. Given the syntactic common denominator, viz, generated in the specifier of the applicative projection, can we find a

semantic common denominator? Another look at the three applicatives can give us a clue.

Swahili

- (40) a. Juma a-li-m-nunul-i-a m-toto ki-tabu (Benefactive)
 Juma 1SA-PST-1OA-bing-APP-FV 1-child 7-book
 Juma bought a book for the child.
- b. m-sichana a-li-wa-sukum-i-a wa-vulana j-ongoo (Goal)
 1-girl 1SA-PST-2OA-push-APP-FV 2-boy 5-milipede
 the girl pushed a milipede towards the boys
- c. fundi a-li-i-kat-i-a mi-taa u-meme (Malefactive)
 1technician 1SA-PST-4OA-cut-APP-FV 4-neighborhood 11-power
 the technician cut power to the neighborhoods.

Benefactive applicatives such as (40a) consist of events performed for the benefit of the beneficiary. In many cases it is ambiguous between the benefit reading and "on behalf of" the beneficiary. In this case too, the event is intended to benefit the beneficiary. The event or action may not be directed to the beneficiary, but the intention is somewhat directed at the applied object. This underlying direction theme is overt in goal applicatives such as (40b) above. In (40c) we have the same characteristics as (40a) the only difference now is that the applied object is affected negatively or something is done to take something away from the applied object. Thus instead of being for the benefit of or on behalf of, we have at the expense of. The picture we get regarding the benefactive applicatives is summarized as (41) below.

- (41) In the benefactive applicative type, the event or action is directly or indirectly aimed at benefiting, reaching or affecting the applied object.

This directive aspect is not found in instrumental and locative applicatives.

5. Conclusion

In this chapter I have examined structural properties of benefactive applicatives. Object properties such as linear precedence, cliticization, passivization, reflexivization and reciprocalization are exhibited by the highest object. I have argued that the applied object in benefactive applicatives is the highest object; that is why it exhibits these properties. In addition, we see that the benefactive can bind into the direct object and not vice versa. With respect to the hierarchy of thematic roles, the constituent-structure diagnostic showed that the benefactive, goal and malefactive are generated between the agent and the theme/patient. Object properties show that these applied objects are high up close to the agent.

There are two problems which have not been solved. One is with respect to wh-extraction of the benefactive. The benefactive can only wh-extract from the clitic position. This characterization of the problem is new and requires a fresh study. The second problem concerns crosslinguistic variation. There are Bantu languages which also allow the direct object to precede the benefactive, cliticize and passivize, properties which I assumed were exhibited by the highest object. This symmetry, however, does not extend to binding. The subject can bind (reciprocally and reflexively) the applied object only. These configurations require further studies.

CHAPTER FIVE

Instrumental Applicatives

0. Introduction

In Chapter 2, I postponed discussion on instrumentals given certain additional complications. I turn to a more systematic description of instrumentals in this chapter. This chapter consists of 5 sections. In Section 1, I discuss restrictions in instrumental applicatives. In Section 2, I review problems raised in the description and propose an analysis of instrumental applicatives. The discussion about the structure centers around the questions regarding the surface argument structure vis-a-vis the constituent structure. I show that the structure proposed so far is inadequate. One of the major inadequacies is handling instrumental typology. The typology of instrumentals becomes the subject of Section 3. Although there are various semantic types, syntactically there are two instrumental types. Evidence for this is found in synthetic compounds and subjectivization. The discussion concludes with a revised proposal of the instrumental applicative structure. Section 4 returns to motive applicatives for which I argue for both a syntactic and semantic instrumental applicative structure. Concluding remarks are made in Section 5.

1. Restrictions

Instrumental applicatives exhibit a number of restrictions which differentiate them from benefactive and locative type applicatives. In this section I discuss restrictions on phonologically realized DPs, cliticization, reciprocal and reflexive interpretation, and passivization.

1.1 Restrictions on Phonologically Realized DPs

It appears that only one DP can be phonologically realized in postverbal position. We saw examples when discussing the syntactic properties of the different applicatives in Chapter 2, § 2.1 that the use of both objects in any order is extremely marginal as the following examples show.

Swahili

- (1) a. ??wa-li-vunj-i-a ch-ungu ma-we
2SA-PST-break-APP-FV 7-pot 6-rock
they broke the pot with rocks
- b. ??wa-li-vunj-i-a ma-we ch-ungu
2SA-PST-break-APP-FV 6-rock 7-pot
they broke the pot with rocks

Both instrumental and motive applicatives exhibit this feature.

If both orders are bad, how are instrumental applicatives realized? There are two common strategies of realizing instrumental and motive applicatives: (a) *wh*-constructions, and (b) cliticization.

1.1.1 Wh-Constructions

The most common forms of *wh*-constructions realizing instrumental applicatives are: (a) infinitival relatives, (b) finite relative clauses and (c) topicalization.

1.1.1.1 Infinitival Relatives

The following examples illustrate different kinds of instrumental type arguments as realized in infinitival relatives.

Swahili

- (2) a. ki-tu ch-a ku-kat-i-a nyama
 7-thing 7-a INF-cut-APP-FV 9meat
 a thing to cut meat with
- b. ki-tu ch-a ku-l-i-a wali
 7-thing 7-a INF-eat-APP-FV 1 rice
 a thing with which to eat rice (spoon for example)
- c. ki-tu ch-a ku-ung-i-a mboga
 7-thing 7-a INF-season-APP-FV 9vegetable
 something with which to season the vegetable
- d. sababu y-a ku-wind-i-a ndovu
 9reason 9-a INF-hunt-APP-FV 2elephant
 reason for hunting the elephants

The instrument (as in (2a,b)), ingredient (2c) or reason (as in (2d)) appears to the left of the non-finite clause. Given that the applied suffix licenses an additional object (the applied object), it can be said that these sentences contain an empty postverbal object position.

As in English, infinitival relatives are not restricted to applied objects. Other arguments can be relativized in this way. In the following examples, gaps in object positions are indicated by [e] and the relativized arguments are indicated in the brackets after the sentences.

Swahili

- (3) a. ki-tu ch-a ku-vuta [e]_i (direct object)
 7-thing 7-a INF-pull
 something to smoke (e.g. tobacco)
- b. ki-tu ch-a ku-vut-i-a [e]_i tumbaku (applied object-instrument)
 7-thing 7-a INF-pull-APP-FV 9tobacco
 pipe (something used in smoking)
- c. m-tu wa [e]_i ku-vuta tumbaku (subject)
 1-person 1-a INF-pull tobacco
 person to smoke tobacco (= person who smokes)

- d. m-tu w-a ku-m-p-a [e]_i zawadi (dative)
 1-person 1-a INF-1OA-give-FV 9present
 a person to give a present to¹
- e. m-tu w-a ku-m-nunul-i-a [e]_i zawadi (dative)
 1-person 1-a INF-1OA-buy-APP-FV 9present
 a person to buy a present for
- f. m-toto w-a ku-zungumz-a na-ye (committative)
 1-person 1-a INF-talk-FV with-her
 a person to talk with
- g. ?m-tu w-a ku-pend-a mi-choro y-ake (genitive)
 1-person 1-a INF-like-FV 4-draw 4-her
 a person to like his paintings

The infinitival relative clause in (3a) modifies a DP which is the direct object DP. In (3b) it modifies the instrument DP and in (3c) it modifies the agent DP. Other examples include a dative DP (3d), committative DP (3f) and a genitive DP (3g) (which gives slightly degraded results). Therefore this phenomenon is not restricted to instrumentals nor to applied objects. Notice examples (3d,e). The goal is cliticized in (3d). A similar phrase without cliticization would be ungrammatical (cf. Chapter 4, § 2.3.5).

These examples are consistent with wh-movement structures. Let us take the following example and analyze the structure.

Swahili

- (4) m-toto_j a-na-hitaji ki-tu_i ch-a PRO_j ku-l-a [e]_i
 1-child 1SA-PRT-need 7-thing 7-a PRO INF-eat-FV [e]
 the child needs something to eat

This position is governed and also Case-marked by the verb "eat". It cannot be a pro because in Ndendeule and Swahili an object pro needs to be coindexed

¹ This clause is easily found in such contexts as the following Swahili sentences:
 Yeye ni m-tu m-baya. Si m-tu w-a ku-m-p-a zawadi.
 She/he is 1-person 1-bad. not 1-person 1-a INF-1OA-give-FV 9present
 She is a bad person. She is not a person to give a present to.

with a clitic with which it shares ϕ -features (cf: Chapter 3, § 3). There is no such a clitic in (4). I conclude that it is a variable. The structure of the complement of the verb *anahitaji* (she needs) is shown in the following tree diagram.

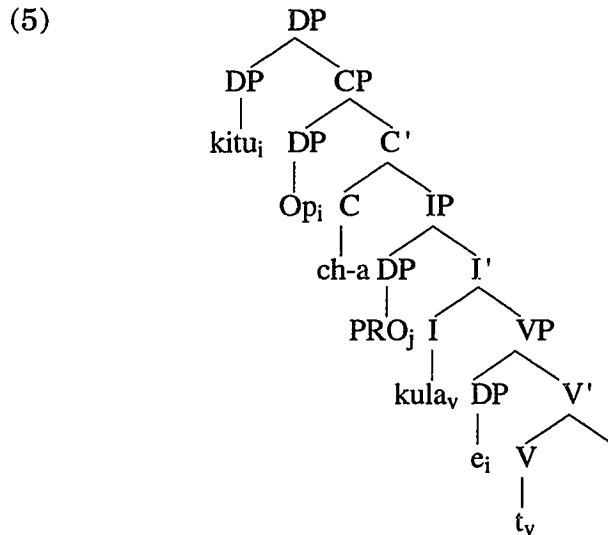

The subject position of the subordinate clause is an ungoverned PRO position. The associative marker is in the C^0 position. The associative marker exhibits gender, person and number features of the head of the relative clause. I assume these agreement features are triggered by a DP in the [Spec, CP] position as a null operator, Op (Chomsky, 1976).

Either object can be the head of such a relative as the following examples show.

Swahili

- (6) a. si-na ki-tu ch-a ku-vut-i-a tumbaku h-ii
 I.NEG-with 7-thing 7-ASS INF-pull-APP-FV tobacco this-9
 I don't have anything to smoke this tobacco with

- b. si-na tumbaku y-a ku-vut-i-a ki-ko h-iki
 I.NEG-with 9tobacco 9-ASS INF-pull-APP-FV 7-pipe this-7
 I don't have the tobacco to smoke in this pipe

The patterns of argument structure in infinitival relatives are summarized below.

(7) Infinitival Relatives

- a. AO ASS INF V-APP DO
 b. DO ASS INF V-APP AO

The same patterns found in infinitival relatives are also found in topicalization to which I now turn.

1.1.1.2 Finite Relative Clauses

Instrumental applicatives can be realized in finite relative clauses as the following examples illustrate.

Ndendeule

- (8) a. ki-hembe cha-βa-ki-heket-é n-kota
 7-knife 7REL-2SA-PST-cut-APP 3-sugar cane
 the knife, with which they cut sugar cane
- b. mbiya hya-βa-ki-hyem-e ndembu
 10money 10REL-2SA-PST-hunt-APP 10elephant
 the money for which they hunted the elephants

In these cases, there is only one object in postverbal position. The instrument in (8a) and the reason in (8b) have moved out of the postverbal positions. Wh-movement can also extract and move the direct object and leave the applied object in postverbal position as shown in the following examples.

Ndendeule

- (9) a. nkota ywa-βa-ki-heket-é ki-hembe
3sugar cane 3REL-2SA-PST-cut-APP 7-knife
the sugar cane which they cut with a knife
- b. ndembu hya-βa-hyem-i mbiya
10elephants 10REL-2SA-hunt-APP 10money
elephants which they hunted for money

In these two sentences, the direct object is relativized and the applied object appears in postverbal position².

1.1.1.3 Topicalization

Either object can be topicalized and occur in sentence-initial position, with the other object appearing postverbally. The following examples illustrate the topicalization of the direct object.

Ndendeule

- (10) a. nkota βa-ki-dumul-i ki-hembe
3sugar cane 2SA-PST-cut-APP 7-knife
the sugar cane, they cut with a knife
- b. ndembu βa-hyem-i m-ino
10elephants 2SA-hunt-APP 6-tooth
elephants they hunted them for their tusks

The direct object appears before the verb, but not in subject position as the subject agreement prefix shows. The subject in these two cases is a pro of noun

² The relative clause in Ndendeule is formed by prefixing a relative marker which agrees with the head noun to the verb. For example:

na-ki-memen-a n-kota ywa-βa-ki-heket-a β-ana
I-PST-chew-FV 3-sugar cane 3REL-2SA-PST-cut-FV 2-child
I chewed the sugar cane which they cut

The relative marker appears like an associative marker.

Class 2 which triggers subject agreement. Note that in the two examples the objects are not cliticized.

The applied object in instrumental applicatives may be topicalized in the same way, as shown in the following examples.

Ndendeule

- (11) a. ki-hembe βa-ki-heket-é n-kota
 7-knife 2SA-PST-cut-APP 3-sugar cane
 the knife, they cut sugar cane with it.
- b. ?m-ino βa-ki-hyem-é ndembu
 6-tooth 2SA-PST-hunt-APP 10elephant
 the tusks, they hunted the elephants for them

The topicalization of the motive in (11b) requires special intonational emphasis in order to be acceptable. I will discuss motive applicatives in Section 4.

The direct object may trigger object agreement even if the direct object has been topicalized and the following examples show.

Ndendeule

- (12) a. nkota βa-ki-u-heket-é ki-hembe
 3sugar cane 2SA-PST-3OA-cut-APP 7-knife
 the sugar cane, they cut it with
- b. ndembu βa-ki-hi-hyem-é m-ino
 10elephant 2SA-PST-10OA-hunt-APP 6-tooth
 the elephants, they hunted them for their tusks

The instrument does not trigger object agreement in this structure as the following examples show.

Ndendeule

- (13) a. *nkota βa-ki-ki-heket-é ki-hembe
 3sugar cane 2SA-PST-7OA-cut-APP 7-knife
 the sugar cane, they cut it with

- b. *ndembu βa-ki-γa-hyem-é m-ino
 10elephant 2SA-PST-6OA-hunt-APP 6-tooth
 the elephants, they hunted them for their tusks

These two examples show that the applied object in instrumental and motive applicatives cannot be cliticized when the direct object is topicalized.

Here again, we must recognize an empty object position for the cases in (11). The fact that we may have topicalization without cliticization suggests a gap in postverbal position resulting from movement to an A-bar position. The topicalized DPs in these cases occupy a non-argument position. Extraction out of the sentences shows subjacency effects as the following sentence shows.

Ndendeule

- (14) a. *γongo ndi n-kota ki-hembe γwa-βa-ki-heket-e
 this-3 is 3-sugar cane 7-knife 3REL-2SA-PST-cut-APP
 this is the cloth the knife with which they cut
- b. *na-ki-memen-a n-kota ki-hembe βa-ki-heket-e
 I-PST-chew-FV 3-sugar cane 7-knife 2SA-PST-cut-APP
 I ate the sugar cane which the knife they cut with

In constructing (14a), I attempted to relativize the direct object, "sugar cane". Hence 3REL marker. This sentence is ungrammatical for at least two reasons. One is that *kihembe* (knife) is topicalized and therefore it is in [Spec, CP] with an empty COMP head. The relative agreement we see (3REL) is for the direct object and is occupying an already filled COMP. The second reason is subjacency. The direct object operator has moved across the CP that has the instrument in the Spec position. This subjacency effect is found also in (14b) where the relative complementizer is not overt.

In sentences where the instrument is topicalized, there cannot be any object agreement, be it with the direct object or with the instrument.

Ndendeule

- (15) a. *ki-hembe βa-ki-u-heket-é n-kota
7-knife 2SA-PST-3OA-cut-APP 3-sugar cane
the knife, they cut the sugar cane with it.
- b. *ki-hembe βa-ki-ki-heket-é n-kota
7-knife 2SA-PST-7OA-cut-APP 3-sugar cane
the knife, they cut the sugar cane with it.

A direct object clitic and a topicalized instrument yield ungrammatical sentence (15a) as does a topicalized instrument and instrument cliticization in (15b). This raises the question of how this pattern can be explained?

The following patterns were obtained from the data on topicalization.

(16) Topicalization

- a. AO Subj Ø V-APP DO
b. DO Subj Ø V-APP AO
c. DO Subj Cl-DO V-APP AO
d. *AO Subj Cl-DO V-APP DO
e. *AO Subj Cl-AO V-APP DO
f. *DO Subj Cl-AO V-APP AO

The same pattern obtained from infinitival relatives is obtained here. Both topicalization and infinitival relatives are *wh*-constructions. Leaving aside all the cases in which the applied object is cliticized, since they require different explanations, one question does arise:

(17) Why is cliticization of the direct object not possible when the instrument is topicalized?

This same question can also be raised for the infinitival relatives. That is, more generally:

(18) Why is cliticization of the direct object impossible when the instrumental DP undergoes wh-movement?

In the three foregoing sections, I have discussed three constructions which realize the instrumental applicative. These are infinitival relatives, topicalization and finite relative clauses. All these are wh-constructions. There are three features that are noted:

- (19) (i) either object can be wh-extracted;
 (ii) cliticization is possible only for the direct object;
 (iii) if the instrument undergoes wh-movement, the direct object cannot cliticize.

1.1.2 Cliticization

The other way of realizing instrumental applicatives is by cliticization. When the direct object is cliticized without doubling, we get grammatical sentences as in the following examples.

Ndendeule

- (20) a. β a-ki-u-heket-é ki-hembe
 2SA-PST-3OA-cut-APP 7-knife
 they cut it with a knife
- b. $\text{?}\beta$ a-ki-u-heket-é ki-hembe n-kota
 2SA-PST-3OA-cut-APP 7-knife 3-sugar cane
 they cut sugar cane with a knife

- c. ?βa-ki-u-heket-é n-kota ki-hembe
 2SA-PST-3OA-cut-APP 3-sugar cane 7-knife
 they cut sugar cane with a knife

In example (20a), the direct object DP is not realized in postverbal position. It is cliticized. But clitic doubling is not possible as the other two examples show. This suggests that in instrumental applicatives, unlike benefactive and locative applicatives, there is only one licensing position for lexical DPs.

1.2 Restrictions on Cliticization

In instrumental applicatives, the distinction between clitic doubling, in which a pronoun or lexical DP, coindexed with the clitic, appears postverbally, and non-doubled cases, in which only one object appears in the postverbal position is very important. First, look at non-doubled cases.

Ndendeule

- (21) a. βa-ki-u-heket-é ki-hembe
 2SA-PST-3OA-cut-APP 7-knife
 they cut it with a knife
- b. *βa-ki-ki-heket-é n-kota
 2SA-PST-7OA-cut-APP 3-sugar cane
 they cut the sugar cane with it.

(21a) is fine with the patient realized as an object clitic, and the instrumental as the postverbal DP. (21b), however, in which the instrument is cliticized and the patient DP is in postverbal position is ungrammatical. It was on the basis of such cases that I concluded in Chapter 2 that the direct object exhibits object properties in instrumental applicatives.

Clitic doubling yields different results, as the following paradigm shows, and none of the possibilities are fully grammatical.

Ndendeule

- (22) a. ??a-ki-u-heket-é n-kota ki-hembe
1SA-PST-3OA-cut-APP 3-sugar cane 7-knife
she cut the sugar cane with a knife
- b. ??a-ki-u-heket-é ki-hembe n-kota
1SA-PST-3OA-cut-APP 7-knife 3-sugar cane
she cut the sugar cane with a knife

The DO AO order in (22a), with clitic doubling of the direct object, yields marginal results. The other possibility is AO DO (22b), also with clitic doubling of the direct object, which is sharply ungrammatical.

Forms of cliticization are summarized in the following patterns which include clitic doubling.

(23) Cliticization

- | | | | | | |
|----|-----------|---------|-------|------|------|
| a. | Subject | CL-DO | V-APP | INST | ∅ |
| b. | *Subject | CL-INST | V-APP | ∅ | DO |
| c. | ??Subject | CL-DO | V-APP | INST | DO |
| d. | *Subject | CL-INST | V-APP | INST | DO |
| e. | *Subject | CL-DO | V-APP | DO | INST |
| f. | *Subject | CL-INST | V-APP | DO | INST |

All cases of clitic doubling appear to be ungrammatical as we can see from (23).

As pointed out earlier, cliticization can co-occur with wh-movement yielding the following pattern.

Ndendeule

- (24) a. nkota βa-ki-u-heket-é ki-hembe
3sugar cane 2SA-PST-3OA-cut-APP 7-knife
and the sugar cane, they cut with

- b. *ki-hembe βa-ki-u-heket-é n-kota
 7-knife 2SA-PST-3OA-cut-APP 3-sugar cane
 the knife, they cut the sugar cane with it.

Topicalization of the direct object which is also cliticized results in a grammatical sentence (24a). In (24b), the instrument is topicalized and the direct object is clitic doubled resulting in an ungrammatical sentence. Here are the three grammatical forms for cliticization and wh-constructions.

- (25) a. Subj Cl-DO V-APP AO
 b. DO Subj Cl-DO V-APP AO
 c. AO Subj Cl-DO V-APP

Thus three important descriptive generalizations emerge:

- (26) a. Only the direct object can cliticize in instrumental applicatives.
 b. No clitic doubling is allowed with a postverbal DP.
 c. No two DPs in postverbal position.

Given the data, two important questions arise:

- (27) a. Given the structure in which the instrument is generated in the bigger VP, why does the direct object cliticize and not the instrument?
 b. Why is clitic doubling disallowed but cliticization is allowed?

I will come back to these questions in Section 2.

1.3 Restrictions on Reciprocal and Reflexive Interpretation

Whereas in benefactive applicatives in which only the applied object can receive a reciprocal or reflexive interpretation, in instrumental applicatives

only the direct object can receive a reciprocal or reflexive interpretation. The following reciprocal constructions illustrate this.

Swahili

- (28) a. wa-levi wa-li-pig-i-an-a fimbo
 2-drunk 2SA-PST-hit-APP-REC-FV 9stick
 drunks hit each other with sticks
- b. *wa-levi wa-li-pig-i-an-a adui y-ao
 2-drunk 2SA-PST-hit-APP-REC-FV 1enemy 1-their
 drunks used each other to hit the enemy

Since the instrument is generated in a position higher than the direct object, why is binding of the instrument impossible?

1.4 Problems with Passivization

Passivization poses problems of a different nature. Unlike the systematic restrictions we find with phonological DPs, cliticization, and reciprocal/reflexive interpretation, results of passivization are not consistent as the following examples show.

Swahili

- (29) a. sufuria i-li-pik-i-w-a samaki
 9pan 9SA-PST-cook-APP-PASS-FV 2fish
 the pan had fish cooked in it
- b. ?samaki wa-li-pik-i-w-a sufuria
 2fish 2SA-PST-cook-APP-PASS-FV 9pan
 fish were cooked in the pan
- (30) a. ?fimbo i-li-pig-i-w-a ng'ombe
 9stick 9SA-PST-hit-APP-PASS-FV 1cow
 with the stick was hit the cow
- b. ng'ombe a-li-pig-i-w-a fimbo
 2cow 1SA-PST-hit-APP-PASS-FV 9stick
 the cow was hit with a stick

- (31) a. ?ki-su ki-li-kat-i-w-a mu-wa
 7-knife 7SA-PST-cut-APP-PASS-FV 3-sugar cane
 with the knife was cut the sugar cane
- b. ?mu-wa u-li-kat-i-w-a ki-su
 3sugar cane 3SA-PST-cut-APP-PASS-FV 7-knife
 the sugar cane was cut with a knife

In these examples, the (a) sentences passivize the instrument and the (b) sentences passivize the direct object. The results are inconsistent. In benefactive applicatives, it is always the beneficiary that can passivize. In instrumental applicatives, some instruments can passivize and some cannot. Some direct objects can passivize and some cannot.

1.5 Distributive Quantifier-Pronoun Binding

The restrictions on phonologically realized DPs are suspended when distributive quantifiers are involved as the following examples show.

Ndendeule

- (32) a. a-ki-dindul-i kila n-dyango pungulu *y-ake*
 1SA-PST-open-APP each 3-door 9key 9-its
 she opened each door_i with its_i key
- b. a-ki-dindul-i kila pungulu n-dyango *w-ake*
 1SA-PST-open-APP each 9key 3-door 3-its
 he opened with each key_i its_i door

In these cases we find both objects realized in postverbal positions. Furthermore, the theme is the quantified phrase in (32a) while (32b) the instrument is the quantified phrase.

2. Analysis

In the course of the discussion about applicative constructions in general and instrumental applicatives in particular, questions have been raised about object properties as well as argument structure. In this section I try to answer some of the questions in an analysis of the instrumental applicative which is distinct from benefactive applicative. I begin this section by returning to unanswered questions as a review of the challenge of instrumental applicatives. Then I present a structure with its derivations. An account of the argument structure based on the proposal is presented.

2.1 Review of the Issues.

An adequate theory must answer the questions about instrumental applicatives that I have raised throughout these three chapters. I repeat the questions here.

2.1.1 Questions

- (33) a. Why does the direct object cliticize and not the instrument which is in the higher VP?
- b. Why does the direct object reciprocalize and not the instrument?
- c. Why does passivization of either object yield inconsistent results?
- d. Given the two positions of objects in the stacked VPs, what are the mechanisms which enable either object to c-command the other?
- e. Why is there only one DP position in postverbal position?
- f. Why is clitic doubling disallowed while cliticization is allowed?

- g. Why is cliticization of the direct object not possible when the instrument is topicalized?
- h. Why is clitic doubling allowed for DistQPs while it is not allowed in other instrumental applicative constructions?

2.1.3 Desirable Results

Any account should not only be able to answer these questions, but should also be consistent with the following basic notions:

- a. VP ellipsis facts: (i) the smallest VP contains the direct object; (ii) the bigger VP contains the instrument and the minimal VP.
- b. Incorporation is movement of head and always adjoining to the left of the host (Kayne, 1994)
- c. Cliticization occurs for the object which linearly precedes the other and is higher than the other.
- d. Instrumental applicatives have a different structural configuration from benefactive applicatives given the syntactic differences of the objects.

The proposal presented will be examined in the light of these assumptions.

2.2 The Structure of Instrumental Applicatives

First, I discuss the basic proposal of the base-generated structures, then I examine possible derivations of the surface forms.

2.2.1 Basic Structure

The basic structure must be consistent with the VP ellipsis facts and the assumptions on incorporation.

2.2.1.1 VP Ellipsis

We saw in Chapter 3 that the instrumental applicative, just as other applicative structures, consists of two targets of VP ellipsis. The first target is the minimal VP which contains the theme/patient. The second target is the VP which contains the applied object together with the minimal VP. The second feature is that the structure must show a local relationship between the verb and its arguments. The direct object is an argument of the lexical verb. Therefore, the minimal VP, which contains the direct object must be headed by the Verb. The larger VP contains the applied object, an argument of the applicative head. Therefore, it is headed by the applicative affix which has the instrument and the minimal VP as its arguments. I will adopt the structure proposed in Chapter 3 and repeated here as (34).

Ndendeule
(34)

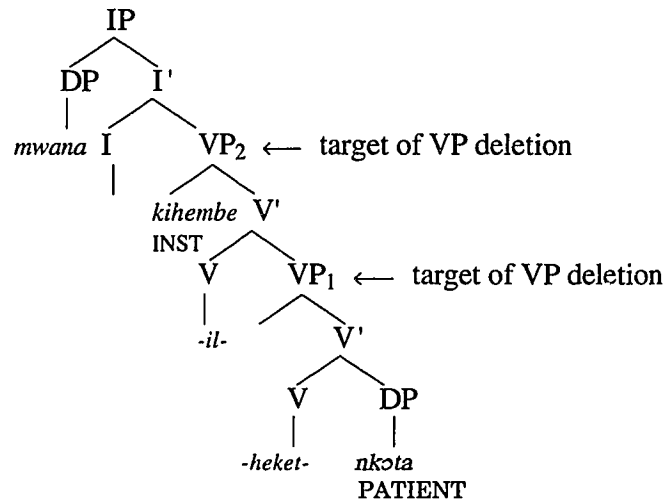

This structure is consistent with the VP ellipsis facts and subcategorization of the two predicates.

2.2.1.2 Verb Incorporation

The structure proposed above is also consistent with verb incorporation features. The applied affix appears always as a suffix to the Verb. In Kayne's model of incorporation (Kayne, 1994), the lower head moves to its governing head and always adjoins to the left of the host. In this case the Verb moves up to adjoin to the left of the host, the applied affix. The resulting order of morphemes is V+APP. The derivation is shown in the following tree diagram.

(35)

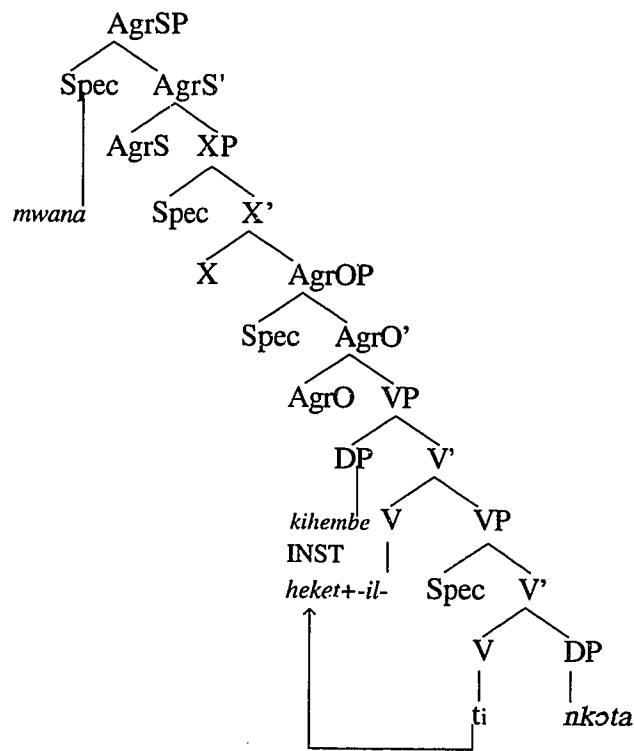

The Verb + APP form a new head, the applicative verb. This moves further to a higher position such as to the head that has been labeled the final vowel (FV) in the glosses.

2.2.2 Argument Licensing

Assuming DPs are licensed in Spec of AGROP, there are three licensing positions: (a) [Spec, AGROP₁], which is available only for the direct object because it is the argument of the verb root; (b) [Spec, AGROP₂], which is available for the applied object and AGROP₁; and (c) [Spec, CLP], which we see from the data can only be occupied by the direct object. Incorporating the features of the universal applicative structure, we obtain the following structure.

(36)

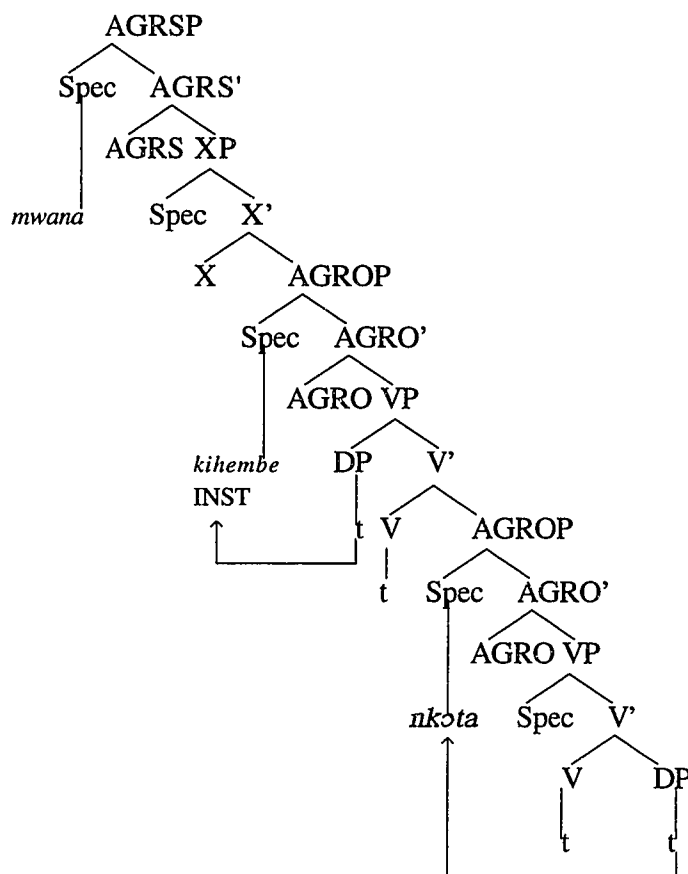

I have abbreviated projections intermediate between AGRSP and AGROP₂ as XP. CLP is one of those projections.

Recall that in the competition for the higher object position manifested by cliticization, it is the direct object which is base-generated lower in our structure that wins. How does this arise? There must be some inversion which places the direct object before the applied object. For some reason this inversion appears to be obligatory. I suggest that AGROP₁ moves to [Spec, AGROP₂]. Thus we get the following partial structure.

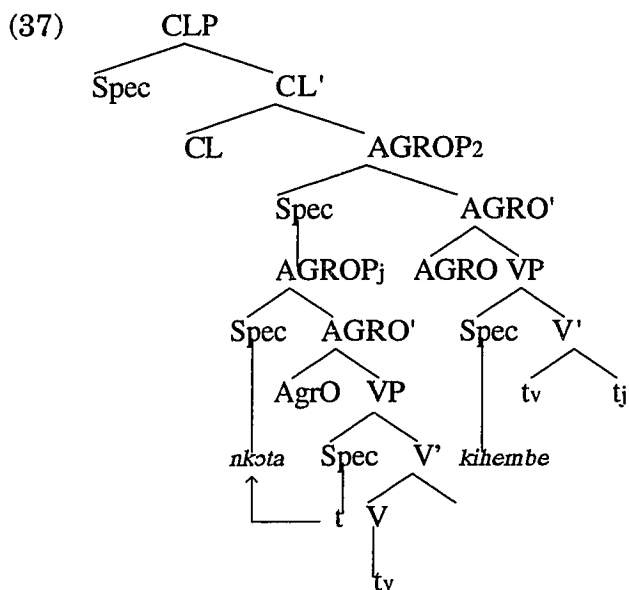

This structure is motivated by the need to: (a) move the direct object to a position closer to the clitic position, (b) maintain the licensing position of non-specific/indefinite direct object, and (c) block any possible movement of the instrument to the clitic.

What does this proposal achieve? This structure has two possible licensing positions for the direct object, [Spec, AGROP_j] for non-specific/indefinite direct objects and [Spec, CLP] for clitics. The instrument DP is not licensed unless it moves to a position higher than CLP. Such positions may be Specs of quantifier phrases (QPs) such as DistQP or wh-positions (Beghelli and Stowell, 1995). Hence wh-movement.

There is a problem which requires a modification of the proposed analysis. In this analysis the Spec of AGROP₂ is occupied by the pied-piped AGROP₁. Therefore, in constructions which have a direct object clitic, how does

the instrument DP get licensed in postverbal position? This suggests there is another position for licensing the instrument DP.

There exists another CLP for such complex predicates as instrumental and motive applicatives. In Ndendeule and Swahili only one CL is overt, the other is phonologically null. The null clitic triggers the realization of a full instrumental DP. Such a CL can be overt as is the case in Kinyarwanda where they have multiple clitics. The following is a structure showing the two CLs.

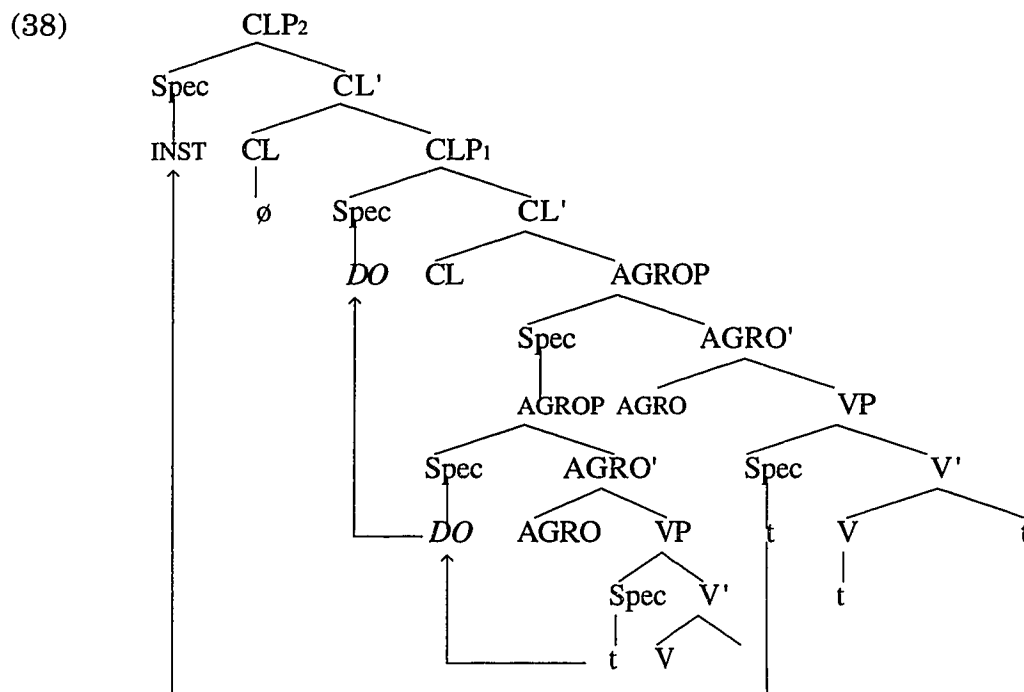

If the direct object occupies the clitic position, the instrument DP moves to the Spec of CLP₂. But when the direct object appears as a full DP, the instrument DP must move to a QP. The motivation for such movement is not yet clear to me.

2.3 QNP-Pronoun

Marantz (1993) showed that in instrumental applicative constructions there is domain symmetry between the direct object and the instrument. Using quantified NP-pronoun relations, he showed that either object can bind into the other. This means either object can asymmetrically c-command the other. The following examples from Ndendeule illustrate this.

Ndendeule

- (39) a. a-ki-dindul-i kila n-dyango pungulu y-ake
 1SA-PST-open-APP each 3-door 9key 9-its
 she opened each door_i with its_i key
- b. a-ki-dindul-i kila pungulu n-dyango w-ake
 1SA-PST-open-APP each 9key 3-door 3-its
 he opened with each key_i its_i door

In both sentences, "key" is the instrument and "door" is the direct object. In (39a), the quantified direct object binds into the instrument DP. Note that the QP linearly precedes the DP containing the bound pronoun. This means the instrument is c-commanded by the direct object. In (39b), however, it is the instrument which is quantified and binds into the direct object. This means the direct object is c-commanded by the instrument.

The facts about domain symmetry in instrumental applicatives raise one problem. We get both sequences of objects here: AO DO (39b) and DO AO (39a). To sum up, there are four points we need to consider: (i) VP ellipsis establishes the instrument as the higher object; (ii) with the exception of DistQP in this section, we found that two object DPs cannot appear in postverbal position; (iii) with DistQP both objects appear in the postverbal position; and (iv) either object can precede the other. I conclude that objects in V DP DP occur in different structural positions from V QP DP. This conclusion

is consistent with the proposal by Beghelli and Stowell (1995) that the DPs raise to QPs and in this case to DistQP.

The fact that the objects are DistQP suggests they move to the DistQP. Beghelli and Stowell (1995) propose that there are five types of quantifiers: (i) interrogative QPs (WhQPs), (ii) negative QPs (NQPs); (iii) distributive-universal QPs (DQPs); (iv) group-denoting QPs (GQPs); and (v) counting QPs (CQPs). Each type has its structural position(s). The different quantifier positions proposed by Beghelli and Stowell are shown in the following structure.

(40)

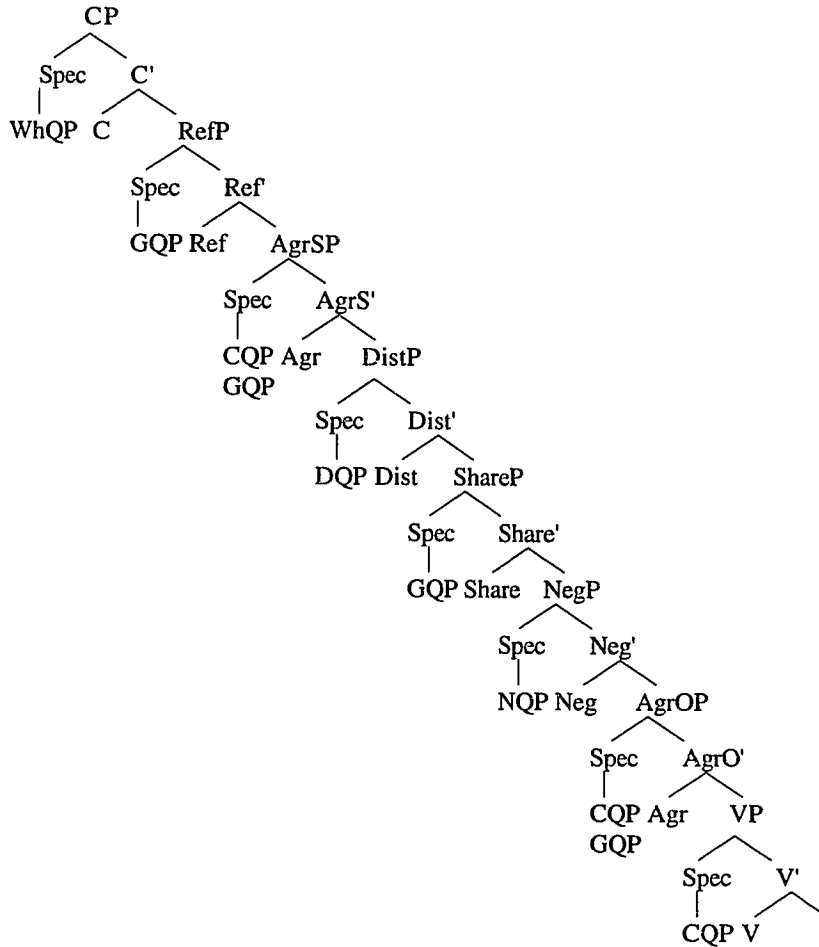

The quantified object moves to the Spec of the DistQP. Because of the asymmetry in base generated structure, I conclude that in these two languages, movement to DistQP is overt. It allows either object to precede the other. As in *wh*-movement, either object can raise to the DistQP. This would seem to indicate that movement to DistQP is also A-bar movement. However, given V AO DO basic structure, (39a) should exhibit weak crossover effects since the trace left by the direct object will be coindexed with the pronoun inside the instrumental phrase. (39a) does not exhibit such weak crossover effects.

With respect to VP ellipsis of instrumental applicatives with DistQs, we find there are restrictions. Consider the following examples from Ndendeule.

- (41) a. a-ki-dindul-í kila n-dyangu pungulu y-ake
 1SA-PST-open-APP each 3-door 9key 9-its
 she opened each door with its key
- b. na ne na-ki-dindul-í kila n-dyangu pungulu y-ake helahe
 and me I-PST-open-APP each 3-door 9key 9-its too
 and I opened each door with its key too.
- c. *na ne na-ki-dindul-í kila n-dyangu helahe
 and me I-PST-open-APP each 3-door too
 and I opened each door too
- d. *na ne na-ki-dindul-í pungulu y-ake helahe
 and me I-PST-open-APP 9key 9-its too
 and I opened with its key too
- e. na ne na-ki-dindul-i helahe
 and me I-PST-open-APP too
 I did too

VP ellipsis may provide further evidence for movement to DistQP. Deletion of either object yields an ungrammatical sentences (41c,d). VP deletion is possible only when both objects are involved as shown in (41e). A simplified

structure of the DistQP and the two VPs can reveal the possible targets of ellipsis.

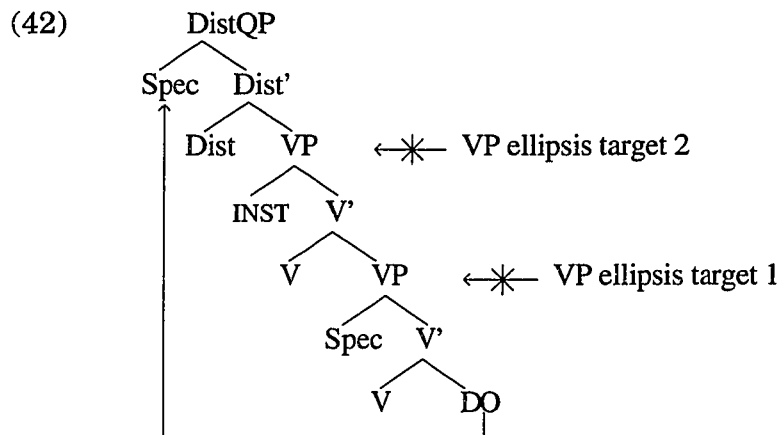

If the minimal VP is deleted, the DO will not be available for movement to the DistQP. Hence the ungrammaticality of (41d). Deletion of the instrument alone is ruled out for independent reasons as discussed before. I suggest that the second target of VP ellipsis is also illicit with respect to DistQP because the direct object will not be available for movement to DistQP. This suggests that the grammatical ellipsis we see in (41e) may be due to targetting the DistQP rather than its constituents.

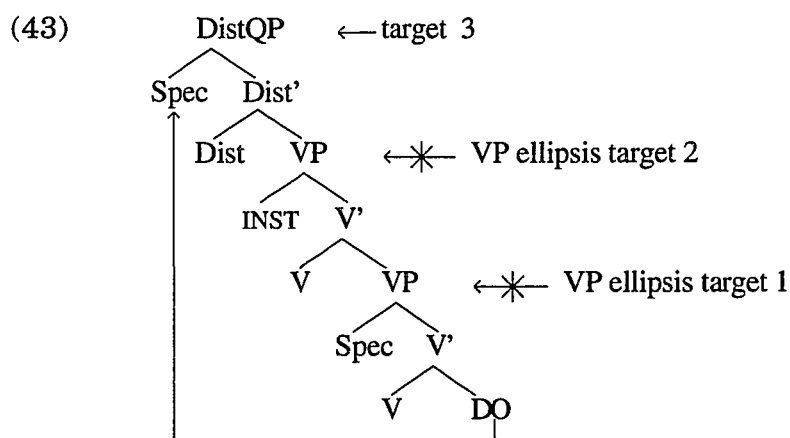

Ellipsis is possible only after the DO has moved to the DistQP. This proposal is supported by facts from another set of data in which it is the instrument that is quantified.

Ndendeule

- (44) a. a-ki-dindul-i kila pungulu n-dyangu w-ake
 1SA-PST-open-APP each 9key 3-door 3-its
 she opened each door with its key
- b. na ne na-ki-dindul-i kila pungulu n-dyangu w-ake helahe
 and me I-PST-open-APP each 9key 3-door 3-its too
 and I opened each door with its key too.
- c. *na ne na-ki-dindul-i kila n-dyangu helahe
 and me I-PST-open-APP each 3-door too
 and I opened each door too
- d. *na ne na-ki-dindul-i pungulu y-ake helahe
 and me I-PST-open-APP 9key 9-its too
 and I opened with its key too
- e. na ne na-ki-dindul-i helahe
 and me I-PST-open-APP too
 I did too

The same pattern is evident here. The instrument cannot be deleted (44c) since it is in the bigger VP. However, movement of the instrument to the DistQP should allow for the deletion of the lower VP containing the direct object. Sentence (44d) is ungrammatical. This could be due to the fact that the bindee is no longer available. It is consistent with the suggestion that the binder has to move to the DistQP before ellipsis can take place. Possibly it is the DistQP that is targetted as shown below.

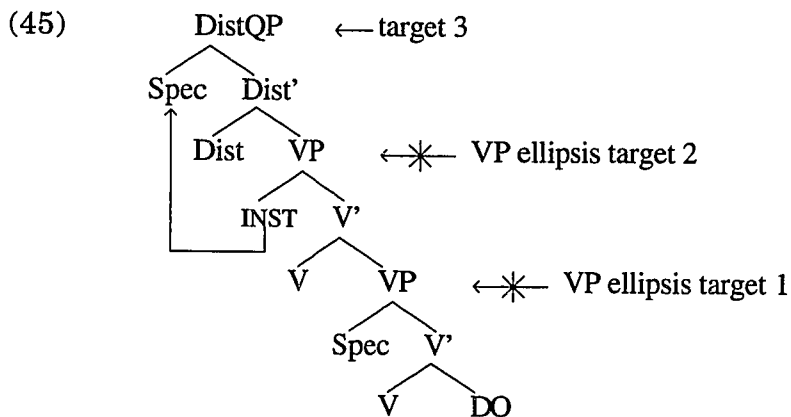

I have discussed the argument structure of instrumental applicatives when one of the objects is a distributive quantifier binding into the other. Following Beghelli and Stowell (1995), I suggest that the object which is a distributive quantifier moves to DistQP. The fact that the only ellipsis realization which is grammatical is the one in which both objects disappear suggests ellipsis targets the DistQP.

The following is a summary of the patterns found in DistQP structures.

(46) Distributive Quantifier Phrases

- | | | | | | |
|----|-------|-------|-------|-----|-----|
| a. | Subj | ∅ | V-APP | QDO | AO |
| b. | Subj | ∅ | V-APP | QAO | DO |
| c. | *Subj | ∅ | V-APP | DO | QAO |
| d. | *Subj | ∅ | V-APP | AO | QDO |
| e. | Subj | CI-DO | V-APP | QDO | AO |
| f. | *Subj | CI-AO | V-APP | QAO | DO |
| g. | *Subj | CI-AO | V-APP | QDO | AO |
| h. | *Subj | CI-DO | V-APP | QAO | DO |

(46c) and (46d) are independently accounted for. The QP does not c-command the pronoun. The QP must linearly precede the phrase containing the bound pronoun. (46f) and (46g) are ungrammatical because of the applied object clitic. The facts raise the following questions:

- (47) a. Given the two positions of objects in the stacked VPs, what are the mechanisms which enable either object to c-command the other?
- b. Why is clitic doubling allowed when one DP is quantified while it is not allowed in other instrumental applicative constructions?

In this section I have attempted to present an analysis of instrumental applicatives. The analysis is based on the proposal I made in Chapter 3 which was based on VP ellipsis facts. I have revised it to include an essential movement of the lower predicate to a higher position. The result of this movement and adjunction is to realign the arguments such that the direct object is adjacent to the verb and may exhibit some of the object properties that the instrument does not exhibit. I suggested that the movement of the lower predicate was motivated by some complexities internal to it. This point, however, was not developed. Evidence for this internal structure comes from studying the typology of instrumentals. This will be the subject of the next section.

3. A Typology of Instrumentals

Although instrumental applicatives are treated as a uniform type of applicatives, they consist of some subtypes. In this section I follow Kural (1993) and Lakoff (1968) in identifying two types of applicatives, aide

instruments and tool instruments. Syntactically these are distinct types and other instrumental type objects such as ingredient (Wald, p.c.) and motive fall in the aide type. Evidence for the typology is presented that also points to the structure of the instrumental applicatives. The structure will fit within the overall picture in which the hierarchy of thematic roles is syntactically determined.

3.1 Aide vs Tool Instruments

In both applicative instrumentals and PP instrumentals, three types of objects may be identified: (48a) aide, (48b) tool and (48c) ingredient. These are shown in the following three examples.

Swahili

- (48) a. ki-jiko, m-toto a-li-l-i-a wali (aide)
 7-spoon, 1-child 1SA-PST-eat-APP-FV 11-rice
 a spoon, the child ate rice with it
- b. ki-su, m-toto a-li-kat-i-a mu-wa (tool)
 7-knife 1-child 1SA-PST-cut-APP-FV 3-sugar cane
 with a knife, the child cut sugar cane
- c. tui la nazi, mama a-li-pik-i-a wali (ingredient)
 5coconut milk, mother 1SA-PST-cook-APP-FV 11-rice
 with coconut milk, mother cooked rice

Semantically, these instrumental objects differ in the extent of their involvement in the event described by the verb. While the spoon helps the child to eat, the knife actually does the cutting. In the second case, the child causes the knife to cut. Coconut milk in (48c) becomes part of the cooked rice. In a way it helps in the process of making edible rice since it flavors it. Hence aide instrument type.

3.2 Evidence for the Typology

There are two arguments which reveal a two-way distinction in the type of instruments. One is synthetic compounds and the other is subjectivization. Both of them reveal the same syntactic typology.

A Bantu synthetic compound is made up of a verb phrase (i.e. V and a complement which can be deleted under certain circumstances) preceded by a nominal class prefix. The following nominals in Swahili are synthetic compounds.

Swahili

- (49) a. ki-gogot-a
7-peck-FV
woodpecker
- b. m-chanj-a kuni
1-split-FV 10firewood
firewood chopper

In sentence (49a) there is no complement to the verb. But there is a complement to the verb in (49b), an NP. I treat them in the same way since they exhibit the same syntactic restrictions. Notice in this case how the two arguments of the verb *chanja* (chop) are revealed. *Kuni* (firewood) is the object of the verb. The prefix /m-/ is the class 1 prefix for the agent. Clearly this shows that the theta criterion is satisfied. Thus the projection principle holds at the level of these derived DPs.

There are six important properties of Bantu synthetic compounds: (a) Synthetic compounds are made of a verb and a complement; (b) The VP is preceded by a noun class prefix such as {m-} in (49b); (c) Although the

synthetic compounds contain VPs they do not contain a clausal projection; as a consequence; (d) They lack agreement, there is no subject agreement nor object agreement; The subject agreement prefix for class 1 is {a-} which is not found in the verb in this case; (e) They lack tense or aspect; (f) Finally there are heavy restrictions on which argument of the V can correspond to the N head. For example, some types of instruments can nominalize and others cannot.

Kinyalolo (1991) proposes, the following structure for synthetic compounds.

Kiswahili

(50) a. ki-kat-a kucha
 7-cut-FV 10nail
 thing that cuts nails -nail clipper

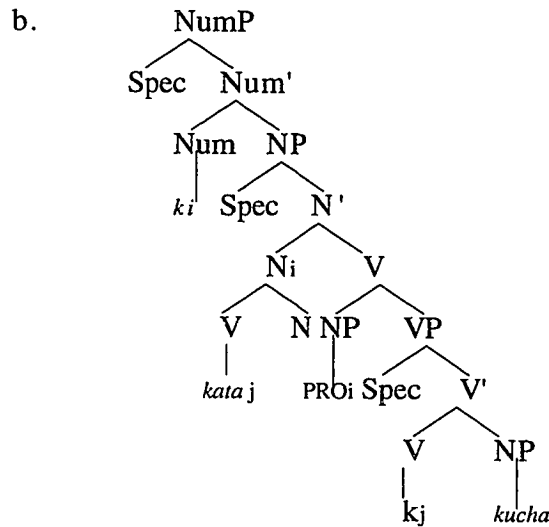

The head of this compound is not overt although it is marked for gender and number features as seen in the nominal prefix. Evidence for this silent head is

found in Swahili where sometimes the head is an overt suffix *-ji* comparable to English *-er*. The *-ji* appears in the next examples.

Swahili

- (51) a. m-kata-ji kuni
 1-cut-NOM 10firewood
 wood chopper
- b. m-cheza-ji
 1-play-NOM
 player

This suffix is possible only with verbs with external arguments (cf. Levin and Rappaport (1988) on externalization of *-er* in English). I therefore adopt the structure in (50b) with the external argument PRO and lacking AGR, T and Case.

The nominalization is derived by head movement of the V to the empty head position of the phrase and coindexation with the PRO. This is how we arrive at the derivation:

- (58) a. [NP [N' [N \emptyset _i] [V_{-max} [NP PRO_i] [VP [V' [V kata] [NP kucha]]]]]]]
- b. [NP [N' [N kata_j + \emptyset _i] [V_{-max} [NP PRO_i] [VP [V' [V t_j] [NP kucha]]]]]]]
-

In cases where the head is the *-ji* (*-er*) in Swahili, the same derivation holds as shown in (59) below, the only difference is that the *-er* head is overt.

- (59) a. [NP [N' [N ji_i] [V_{-max} [NP PRO_i] [VP [V' [V kata] [NP ...]]]]]]]
- b. [NP [N' [N kata_j + ji_i] [V_{-max} [NP PRO_i] [VP [V' [V t_j] [NP ...]]]]]]]
-

The verb adjoins to the left of the N and adjoins to the right giving us the correct surface order of the morphemes (Kayne's incorporation).

The PRO is in the subject position for agents and instruments. Since the head controls PRO, the head should be agentive. The formation of synthetic compounds is restricted to items which appear as subjects in clauses. This is indeed the case since some instrumental objects may be derived by synthetic compounds and some may not be derived in this way. In the following examples from Swahili we find that tool instruments may only be derived by synthetic compounds.

Swahili

- (52) a. ki-kat-a kucha
7-cut-FV 10nail
thing that cuts nails -nail clipper (tool)
- b. *ki-l-a wali
7-eat-FV 11rice
thing that is used in eating rice (aide)
- c. *ki-pik-a wali
7-cook-FV 11rice
thing that is used in cooking rice (ingredient)

Example (52a) is the tool instrument that has been derived by synthetic compounds. Aide (52b) and ingredient (52c) may not be derived in this way.

It is interesting to note that all the examples are based on non applicative compounds. This is due to the fact that instrumental applicatives are excluded from such synthetic compounds. Other applicatives may form synthetic compounds as the following examples show.

Swahili

- (53) a. ki-kata kucha
7-cut-FV 10-nail
nail clipper

- b. *ki-kat-i-a kucha
7-cut-APP-FV 10nail
nail clipper
- c. m-chum-i-a tumbo
1-harvest-APP-FV 5-stomach
one who works for the stomach
- d. m-chum-i-a jua-ni hu-l-i-a ki-vuli-ni
1-harvest-APP-FV 5sun-LOC HAB-eat-APP-FV 7-shade-LOC
a person who harvests in the sun, goes to eat in the shade
(Swahili proverb, Farsi (1958))

The instrument argument depends on the verb. The same patterns exhibited by the instruments in (52) are evident in cases of subjectivization as shown below. It is important to note here again that there is no applied morphology in these cases.

Swahili

- (54) a. ki-su ki-na-kat-a mi-wa vi-zuri
7-knife 7SA-PRT-cut-FV 4-sugar cane Adv-good
the knife cuts sugar cane well
- b. *ki-jiko ki-na-kul-a wali vi-zuri
7-spoon 7SA-PRT-eat-FV 1rice Adv-good
the spoon eats rice well
- c. *tui li-na-pik-a wali vi-zuri
5coconut milk 5SA-PRT-cook-FV 1rice Adv-good
the coconut milk cooks rice well

I therefore conclude that the syntactic properties of the instrument depend to some extent on the verb that selects it.

3.3 Accounting for the Typology

I have shown, using VP ellipsis, that all applicatives involve two VPs with the applied morpheme as the matrix verb. The applied object in all cases appears in the specifier of the applicative projection. Following Kural (1993)

c. I cut my tongue with the knife

d. the knife cuts

Again in *eat*, the knife is only an aide, while it is a tool in *cut* VP. This means that what determines the role of the instrument as a tool or aide is the predicate. It is not an inherent property of the instrument. This shows that the typology is to a large extent due to the semantic nature of the root verb. The verb *cut* selects [\pm animate] in the subject position. The verb *eat* selects only [+animate] in the subject position.

Before I put forward my proposal, I need to reiterate four important points which are a guide to the proposal. The first one is the universal applicative structure in which the applied object is an argument of the applied affix and the direct object is an argument of the Verb. This minimal V DO is a complement of the applicative head. The second is that there exists syntactic evidence that shows there are two types of instrument: tool and aide instruments (Kural, 1993; Lakoff, 1968). The proposal must show this distinction. The third point is that the verb imposes selectional restrictions on the instrument. Given that the overt instrument is an argument of the applicative head, it is not in a local relationship with the Verb which imposes the selectional restrictions. The overt instrument cannot be an argument of both heads since this would violate the theta criterion. There must be another position which is coindexed with the instrument to allow for the restrictions. Fourthly, of the two instruments, the tool is selected by the Verb. Which

means the lower predicate must also have a position which is coindexed to the instrument appearing in the higher Spec position.

The proposed structure has three important features: The first feature is that it is biclausal involving a causative-like structure. The applicative functions as a causative head. The agent may cause the tool instrument to do something as in (55a). Alternatively, the aide helps the agent to do something. At this point it is better to introduce the phrase marker of this proposal.

(58)

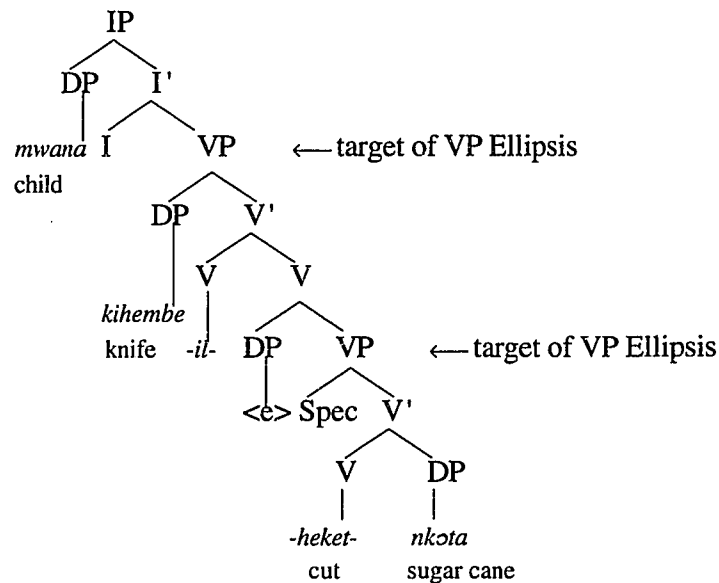

In this structure I have indicated external argument positions for the lower predicate with <e>. The second feature of the proposal is that there is a phonologically null subject position in the lower clause. This must be empty because the only DP realized must be an argument of the applicative. The third feature is that the empty subject position is occupied by an implicit argument because it is the one that determines the syntactic behavior of the instrumental applicatives.

The question then is how does the implicit argument determine the type of the instrumental applicative? The typology is determined by the co-indexation of the implicit argument. For an implicit argument to have syntactic effects is not unusual. Indeed studies have shown that the external argument in passive constructions is an implicit argument which has syntactic effects (Jaeggli, 1986; Roeper, 1984; Baker, Johnson and Roberts, 1989).

If we adopt Kural's idea that in tool instrumentals, the agent causes the tool to be involved in the event denoted by the Verb, we can see that the tool is involved in the lower clause. That is, the applied object (instrument) is coindexed with the implicit argument of the lower clause. This is shown in the following structure:

(59)

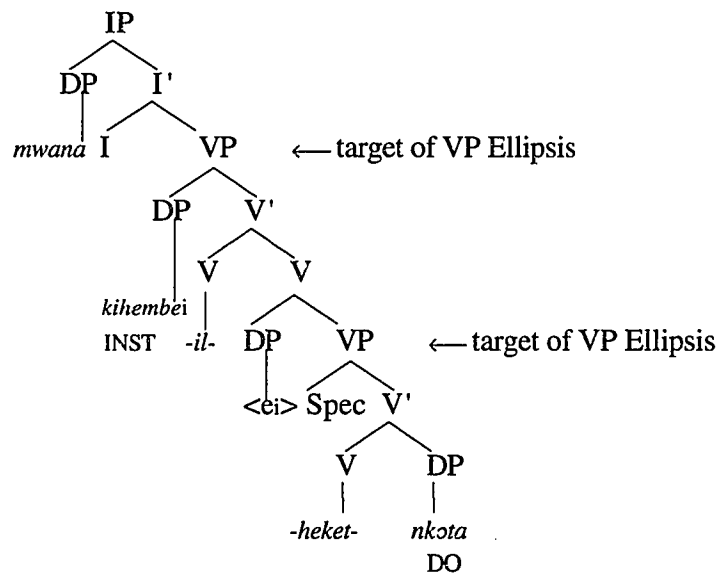

This structure is consistent with all the features of the applicative construction. It also shows the local relationship between the Verb and the tool which is distinct from that of the applied object and the applicative head. Therefore it does not violate the theta-criterion.

How does this structure differ from that of *aide instrument*? I will assume again the existence of an implicit argument in the lower clause. However, as discussed already, the *aide* is not selected by the verb. The relationship between *aide* and the Verb, therefore, is not local. An *aide instrument* does not fill the subject position of the lower clause. I have suggested that the *aide* in a way helps the agent to be involved in the event denoted by the Verb. I map the relationships on the tree diagram below.

(60)

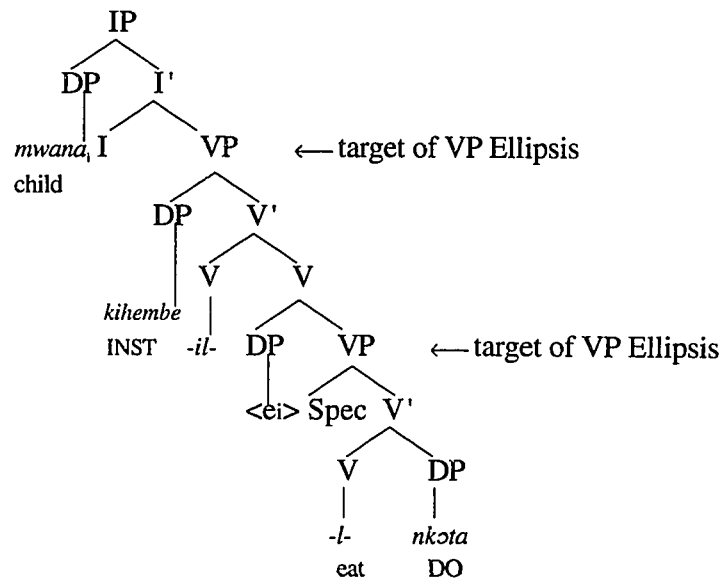

The agent of the matrix clause is also involved in the lower clause. Therefore the co-indexation we see in aide instruments is between the implicit argument position and the subject of the matrix clause.

The final question to be considered here is what does this proposal explain? This proposal explains at least four things. The first is that the typology of instrumentals is not only semantic, it is also structural. Secondly it shows the potential differences that exist between instrumental applicatives and benefactive applicatives in which no bi-clausal structure is proposed. Thirdly, although this proposal has not included a detailed explanation of the reasons for the particular behavior of instrumental applicatives in which I suggested the lower VP raises to a higher position, there is some suggestion in my proposal that the reason lies in the complex nature of the lower predicate in instrumental applicatives. Fourthly, the hierarchy of thematic roles is structurally represented with the tool closer to the patient/theme than the aide instrument. Considering that the contrast with benefactives that we saw are higher up in the tree, we get the following hierarchy of thematic roles.

(61) agent > beneficiary > aide > tool > patient/theme

4. Motive Applicatives

Motive applicatives behave like instrumental applicatives in many ways. First there are restrictions on phonological DPs in postverbal position (cf. Chapter 2). The most common forms of motive or reason applicatives are topicalization and infinitival relatives as shown below.

Swahili

- (62) a. ndovu wa-li-wa-wind-i-a pembe z-ao
2elephant 2SA-PST-2OA-hunt-APP-FV 10horn 10-their
elephants, they hunted them for their tusks
- b. sababu y-a ku-vunj-i-a u-rafiki
9reason 9-a INF-break-APP-FV 14-friend
reason for breaking friendship³

In (62a) the direct object is topicalized leaving the reason DP in the postverbal position. The applied object is not an optional element. In (62b) the reason is the head of the infinitival relative. These forms allow for the realization of only one object in postverbal position as in instrumental applicatives.

Apart from these preferred forms, in Chapter 2 I classified motive/reason applicatives together with instrumental applicatives because of striking similarities between the direct object properties in the two types. These are cliticization of the direct object and reciprocalization of the direct object. We also saw that passivization of either object is problematic. Examples of each property will be illuminating. The following are examples of cliticization.

Ndendeule

- (63) a. ndembu βa-ki-yi-hyem-é mbiya
9elephant 2SA-PST-9OA-hunt-APP 10money
the elephant, they hunted it for money
- b. *mbiya βa-ki-hi-hyem-é ndembu
10money 2SA-PST-10OA-hunt-APP 9elephant
money, they hunted the elephant for it (money)

³ Probably not different from:

sababu y-a ku-vunj-a u-rafiki
9reason 9-a INF-break-FV 14-friend
reason for breaking friendship

We see that the direct object is topicalized and cliticized in (63a), a grammatical sentence. In (63b) the motive is topicalized and cliticized resulting in an ungrammatical sentence.

This is true for anaphoric binding also. Only the direct object can reflexivize or reciprocalize.

Ndendeule

- (64) a. β a-ki-kom-an-í mw-ikeye
 2SA-PST-kill-REC-APP 1-woman
 they hit each other because of a woman
- b. * β a-ki-kom-an-í mw-ikeye
 2SA-PST-kill-REC-APP 1-woman
 they killed the woman because of each other

The reciprocalization of the direct object in (64a) is good, but it is not possible to get the reading in which the the applied object is reciprocalized as (64b) shows.

These forms all show interesting syntactic similarities between instrumental applicatives and reason/motive applicatives. This suggests semantic affinity between instrumentals and motive/reasons.

There are minor differences however. For example, judgments on the following sentences are different.

Swahili

- (65) a. ?ma-we ya-li-vunj-i-w-a ch-ungu (Instrumental)
 6-rock 6SA-PST-break-APP-PASS-FV 7-pot
 the rocks were used to break a pot
- b. *pеса zi-li-wind-i-w-a ndovu (Purpose)
 10money 10SA-PST--hunt-APP-PASS-FV 9elephant
 money was the purpose for hunting the elephant

The passivization of the motive (65b) is worse than the passivization of the instrument (65a). When the direct object is passivized, the result is marginal in both cases.

Swahili

- (66) a. ?ch-ungu ki-li-vunj-i-w-a ma-we
 7-pot 7SA-PST-break-APP-PASS-FV 6-rock
 the pot was broken with rocks
- b. ?ndovu wa-li-wind-i-w-a pesa
 2elephant 2SA-PST-hunt-APP-PASS-FV 10money
 elephants were hunted for money

However, results of passivization are unreliable because they are not consistent. Therefore, the differences seem quite minor compared to their similarities.

5. Conclusion

The proposal for the instrumental applicative construction has two parts. First the instrumental applicative is a biclausal structure. The lower clause (the clause of the verb root) which contains an empty subject position that behaves like an implicit argument of the passive. This structure is consistent with the VP ellipsis facts because the two VPs are intact. The only difference from the universal applicative structure proposed earlier is that in this proposal the lower predicate is not a simple VP but a more complex structure, namely a clause. The proposal is consistent with the hierarchy of thematic roles.

This proposal also distinguishes two types of instrumental applicatives: (i) tool instruments involve coindexation between the instrument and empty subject position; and (ii) aide instruments which are not coindexed with the

subject of the lower VP. Instead, the subject of the matrix clause is coindexed with the empty position.

CHAPTER SIX

Locative Applicatives

0. Introduction

This chapter examines the properties of locative applicatives and contrasts locative applicatives with instrumental and benefactive applicatives. The following examples from Ndendeule and Swahili illustrate the locative applicative construction.

Ndendeule

- (1) a. β a-na β á-ki-lóngel-é pa-lu- β anja
2-child 2SA-PST-converse-APP 16-11-playing ground
children conversed on the playgrounds

Swahili

- b. wa-toto wa-li-zungumz-i-a m-pira u-wanja-ni
2-child 2SA-PST-converse-APP-FV 3-ball 11-ground-LOC
children talked about the ball on the playground

These examples show one distinctive property of locative applicative constructions that sets them apart from all other applicatives. The first one, the applied object, has locative morphology indicated by a locative class prefix in Ndendeule (16 in (1a)) or LOC in Swahili (1b). The second property is that in both languages, locative applicatives are realized with the direct object preceding the applied object. Locative applicatives have another property that is not evident in these examples. In Swahili, where a passive form exists, either object can passivize. Another property is that similar to instrumental applicatives, the direct object can cliticize and reciprocalize.

On account of these distinctive properties, locatives must be studied separately. This chapter begins by examining the unique properties of the locative argument (Section 1). Section 2 describes the other object properties such as cliticization and reciprocalization. The interaction of the different properties is accounted for in Section 3. Section 4 concludes this chapter.

1. The Locative Argument

The locative argument has unique morphological, semantic as well as syntactic properties that distinguish it from other nominal objects. It has both DP and PP properties. These properties are responsible for the distinctive behavior of locative applicatives.

1.1 Morphological Properties

The locative argument is made up of a noun with a locative affix. The affix can be a prefix as in Ndendeule or a suffix as in Swahili. There are three locative prefixes labelled traditionally in Bantu studies as Classes 16, 17 and 18. The following examples illustrate the locative class prefixes in Ndendeule.

Ndendeule

- (2) a. β a-na β -i-kin-í pa-lu- β anja
 2-child 2SA-PRT-play-APP 16-11-playing ground
 children are playing on the playgrounds
- b. β a-na β a-ki-yend-a ku-kaya
 2-child 2SA-PST-go-FV 17-9-home
 children went home
- c. β a-na β a-ki-til-í mu-nyumba
 2-child 2SA-PST-run-APP 18-9-house
 children ran into the house

The locative class prefix precedes another noun class prefix. In (2a), the locative is prefixed to Class 11 noun with a prefix *lu-*. The locative prefix Class 16 (*pa-*) appears before this noun class prefix. In (2b, c) also, Class 9 prefix follows the locative class prefixes. These locative phrases are translated as prepositional phrases in English as the glosses show.

Swahili, in contrast to Ndendeule, does not have the locative class prefixes although the prefixes resurface as agreement. Instead there is a suffix attached to the noun. The suffix *-ni* is used to make non-proper nouns locative phrases. The following examples from Swahili parallel the ones for Ndendeule cited above.

Swahili

- (3) a. wa-toto wa-li-chez-e-a m-pira u-wanja-ni
 2-child 2SA-PST-play-APP-FV 3-ball 11-ground-LOC
 children played ball on the playing field¹
- b. wa-toto wa-li-end-a nyumba-ni
 2-child 2SA-PST-go-FV 9house-LOC
 children went home
- c. wa-toto wa-li-ji-fich-a nyumba-ni
 2-child 2SA-PST-REF-hide-FV 9house-LOC
 children hid in the house

These three examples represent the three Bantu locative classes (Classes 16, 17 and 18). The uniform locative suffix *-ni* does not tell to which of the locative classes these phrases belong.

The following table puts the locative phrases from the two languages side by side for easy reference.

¹ Another possible reading for this sentence is: "The children played with the ball on the playing field."

(4) The morphological structure of locatives in Ndendeule and Swahili

<i>Class</i>	<i>Ndendeule</i>	<i>Swahili</i>
16	pa + Cl + N	Cl + N + ni
17	ku + Cl + N	Cl + N + ni
18	mu + Cl + N	Cl + N + ni

How do we know that there are three locative classes in Swahili? The fact that there are three locative classes in Swahili is established by agreement patterns which are identical to the Ndendeule agreement patterns and to the specific prefixes. I will demonstrate this using subject agreement and demonstratives. The three examples in (13) below show subject agreement with different locative classes.

Swahili

(5)

a. u-wanja-ni pa-na wa-toto w-engi
 11-ground-LOC 16SA-with 2-child 2-many
 on the playing grounds there are many children

b. nyumba-ni ku-na wa-geni
 9-house-LOC 17SA-with 2-guest
 at home there are guests

c. ch-umba-ni m-na nyoka
 7-room-LOC 18SA-with snake
 in the room there is a snake

The verb in all the three sentences is *to be with/to have*. Existential sentences in Swahili make use of the verb *to be with/to have* and the subject agreement morpheme agrees with one of the locative classes. Thus the agreement in (5a) is Cl 16, in (5b) it is Cl 17 and in (5c) it is Cl 18. The actual subject agreement prefixes used are, respectively, *pa-*, *ku-* and *mu-*. These are the same locative

prefixes found in Ndendeule (4) above. In Ndendeule, these are found as subject agreement prefixes as well as prefixes of the locative arguments.

Another set of evidence comes from demonstratives. All demonstratives agree with the noun. The following examples show the agreement between the demonstrative and the head noun.

Swahili

- (6) a. u-wanja-ni h-apa
11-ground-LOC this-16
at these playgrounds
- b. m-lima h-uu
3-mount this-3
this mountain
- c. ch-umba h-iki
7-room this-7
this room

These examples show that the demonstrative exhibits the gender and number features of the head noun.

There are three demonstratives: (i) near the speaker, (ii) near the hearer and (iii) away from both the speaker and the hearer. Whether something is near the hearer or not depends very much on the context of discourse. It may be physically located near the hearer or it may have been mentioned in previous discourse. From the point of view of the speaker, we can say there are two forms for *that*. For ease of reference I will use *this_{me}* for "near", *that_{you}* for something "near the hearer" and *that_{her}* for something "distant to both the speaker and hearer"². In the following set of examples, I illustrate the three locative agreement prefixes by using *this_{me}*.

² The morphological structure of the Swahili demonstrative can be summarized as follows:

Swahili

- (7) a. ha-pa u-wanja-ni
this-16 11-ground-LOC
right here at the playing grounds
- b. hu-ku nyumba-ni
this-17 9-house-LOC
here at home/ around here at home
- c. hu-mu ch-umba-ni
this-18 7-room-LOC
here inside this room

Ndendeule³

- (8) a. pa-lu-βanja pa-m-ba
16-11-ground 16-this-16
at these grounds
- b. ku-lu-βanja ko-n-go
17-11-ground 17-this-17
to these grounds
- c. mu-ch-umba mo-m-bo
18-7-room 18-this-18
in this room

The class agreement markers of the demonstrative are *pa-*, *ku-* and *mu-* for classes 16, 17 and 18 respectively. These are the same as those shown in (4) for subject agreement and, more importantly, the same as the locative class

-
- (a) *This*: h + V + Cl. There are three parts: the consonant /h/ followed by a vowel and finally the class agreement marker. The quality of the vowel is determined by the V of the agreement marker. e.g. h-a-pa, h-u-ku.
- (b) *That_{you}*: h + V + Cl + o. Two defined segments: the initial /h/ and the final /o/. The V and Cl are the same as those found in (a) with one important exception: the vowel of Cl is not phonologically realized. e.g. h-a-p-o, h-u-k-o.
- (c) *That_{her}*: Cl + le. The phonologically defined part is /-le/. The class agreement marker forms the first part of the demonstratives. e.g. pa-le, ku-le.

- ³ The morphological structure of the Ndendeule demonstratives is summarized as follows:
- (a) *This*: Cl-N-Cl. The agreement marker appears at the beginning and the end of the demonstrative. This always yields two syllables. The onset of the second syllable becomes a prenasalized stop. e.g. βamba, yonjo, mombo, etc.
- (b) *That_{you}*: Cl-ɛn-V. The same agreement markers are used as in *this*. The vowel of the agreement marker is affected by some hiatus resolution mechanisms such as glide formation or vowel harmony etc. eg βa+ɛn-V > βena; yo+ɛn-V > yweno. The quality of the final vowel is determined by the vowel of the agreement marker.
- (c) *That_{her}*: Cl-la. The same agreement marker is used. eg βala, yola, mola.

prefixes found in Ndendeule (2) and many other Bantu languages. Thus although Swahili locative phrases do not have overt class prefixes, they can be classified in the same way as Ndendeule and other Bantu locatives. The locative arguments behave in the same way as nominal arguments with respect to other elements of the sentence.

1.2 Meaning

The locative argument carries a “place” meaning. This can be regarded as the gender of the three classes (Carstens, 1991). All nominals have gender features which can be seen in various forms of agreement. Locatives share this property of having gender with nominals. Each class in this gender is specified for one of the following three interpretations which I adopt from Ashton (1947:126).

- (9) Interpretation of Locative Classes:
- a. Class 16: Definite place, position
 - b. Class 17: Some location, direction
 - c. Class 18: “Withinness”, area, “alongness”

Ashton's semantic description is based on Swahili but is valid in Ndendeule and other Bantu languages as well. In locative applicatives, the locative argument specifies the location where the event takes place. Therefore it can be a definite location (15a), a general location (15b) or a location inside some limits (15c)⁴.

⁴ The locative prefixes are found in various agreement contexts referring to place. In some contexts, however, the prefix for Class 16 is used for time. The following two examples show relative markers on the verb:

1.3 Distributional Properties of Locative Arguments.

The morphological and semantic properties of the locative arguments discussed raise the question: what is the syntactic category of the locative phrase? Is it a DP or a PP? The locative phrase has both NP and PP distributional properties. This contributes to both the similarity and differences from the applied objects in instrumental applicatives. I will briefly examine the distributional properties of locative arguments in order to account for the similarities and contrasts.

1.3.1 Locative Phrases as DPs

Traditionally, the locative phrases in Bantu languages have been analyzed as noun phrases and the locative prefixes have been included in the list of noun class prefixes as Classes 16, 17 and 18 (Meinhof, 1932). The locative phrases are classified together with other nouns, because just like nouns, they occur as subjects, objects, and complements of prepositions. In addition, they trigger agreement just like nouns. The following examples show that locatives, like nouns, can appear in subject positions.

-
- i. ki-li-cho-fik-a
7SA-PST-REL7-arrive-FV
which has arrived
 - ii. a-li-po-fik-a
1SA-PST-REL16-arrive-FV
when she arrived

In the first example, a class 7 item is relativized. In the second example, class 16 is used for time, although *wakati* (time) is a class 11 item. The locative demonstrative *huku* is also used to introduce verbs marked with aspectual *-ki-*. For example:

- iii. hu-ku a-ki-end-a
this-17 1SA-IMPF-go-FV
as she was going

Swahili

- (10) a. mwalimu a-na wageni
1-teacher 1SA-with 2-guest
the teacher has guests
- b. nyumba-ni pa-na wageni
9-house-LOC 16SA-with 2-guests
the home has guests/ there are guests at home
- c. nyumba-ni ku-na wa-geni
9-house-LOC 17SA-with 2-guests
at home are guests /there are guests at home
- d. nyumba-ni m-na wa-geni
9-house-LOC 18-with 2-guest
in the house there are guests/ there are guests in the house

Sentence (10a) has a DP agreeing with the V in subject position. This same distribution holds for locatives which trigger locative agreement with the verb (10b,c,d). This phenomenon is treated by Bresnan and Kanerva (1989) as equal to locative inversion. I further discuss locative inversion in Section 3.3 of this chapter.

Similarly, the direct object position can be occupied by a locative. The following examples from Ndendeule show locatives and non-locatives in direct object positions.

Ndendeule

- (11) a. na-ka-hi-pai homo h-ino
I-RP-10OA-like 10story 10-your
I liked your stories
- b. na-ka-pa-pai pa-kaya p-ino
I-PR-16OA-like 16-9-home 16-your
I liked your home
- c. na-ka-ku-pai ku-kaya kw-ino
I-PR-17OA-like 17-9-home 17-your
I liked your home

- d. na-ka-mu-pai mu-kaya mw-ino
 I-PR-18OA-like 18-9-home 18-your
 I liked the inside of your house/home

In (11a), "your stories" is the direct object. In (11b,c,d) the direct objects are the locatives. Both the DP and the locative phrase trigger object agreement. This is true for Swahili as well.

It is not only in sentence positions that we find locatives. Locatives appear also as complements of prepositional phrases as in the following.

Ndendeule

- (12) a. ta-ki-tyang-a kuhuma ku-kaya mpaka ku-ma-lambu
 we-PST-walk-FV from 17-9home to 17-6-plains
 we walked from home to the plains
- b. mbuhi hi-β-i nkati mu-ki-βaya
 10goat 10-be-PERF inside 18-7-kraal
 the goats are inside the kraal

Although the preposition is used for emphasis in (12b), the two prepositions in (12a) are appropriately used in non-emphasis context. This applies to Swahili too.

Like nouns, locatives may be modified by adjectives. This is illustrated in the following phrases.

Ndendeule

- (13) a. pa-kaya pa-maha
 16-9home 16-good
 good home
- b. ku-ki-liβa ku-tali
 17-7-well 17-far
 far to the well

- c. mu-ch-umba mu-pile
18-7-room 18-black
the dark inside of the room

Although I must admit the translations do not do justice to the Ndendeule phrases, they nevertheless illustrate the point. Locatives of all three classes are modified by adjectives and trigger agreement on the adjectives just like nouns.

To summarize, locatives have traditionally been considered nouns for distributional reasons. They occur in the same DP positions such as subject, direct object, and complement of preposition. They trigger agreement in those positions as well as on demonstratives and adjectives.

1.3.2 Locatives as PPs

Although the picture painted so far indicates that locatives have some properties of nouns, there are features which show that locatives behave like prepositions, or at least behave differently from nouns. There are morphological, semantic and syntactic features that identify locatives with PPs.

1.3.2.1 Morphological Argument

In Section 1.1, I discussed the morphological properties of locatives. I showed that the locative consists of the root, a nominal prefix and a locative affix. This means there is double class marking in locatives: there is the locative class marker and the noun class marker. There is more than one head. This kind of structure is similar to other cases of double prefixes such as diminutive and augmentative forms shown in (14b) and (14c) respectively.

Ndendeule

- (14) a. mu-ki-huhi (locative)
16-7-nest
inside the nest
- b. ka-ki-huhi (diminitive)
12-7-nest
small nest
- c. yu-ki-huhi (augmentative)
21-7-nest
big nest

This shows locative prefixes do not behave like other nominal class prefixes because there is a head that selects the head of the DP. As Carstens (1991) suggests the diminitive and augmentative prefixes are not gender prefixes. They are degree heads.

1.3.2.2 Semantic Argument

The main argument for considering locatives as prepositional phrases is that they function as prepositional phrases. Consider the following alternative expressions:

Swahili

- (15) a. ni-li-wek-a ki-tabu sanduku-ni
I-PST-put-FV 7-book 5box-LOC
I put a book in/on the box
- b. ni-li-wek-a ki-tabu katika sanduku
I-PST-put-FV 7-book in 5box
I put a book in the box

The location, which is a complement of the verb, is expressed as a locative in (15a) and as a prepositional phrase in (15b). The locative affix in sentence (15a) can mean *on* the box or *in* the box. But (15b) which has an overt

prepositional phrase means *in* the box. The type of ambiguity which is found in Swahili is not found in Ndendeule where the three locative prefixes are used. The point is that the locative affixes appear in complementary distribution with PPs.

1.3.2.3 Syntactic Argument

The following examples from Ndendeule show that the distributive quantifier *kila* which appears before the DP it quantifies can appear before the locative marker or between the locative marker and the noun.

Ndendeule

- (16) a. ta-ki-βek-a mbuhi mu kila ki-βaya
 we-PST-put-FV 10goat 18 each/every 7-kraal
 we put goats in each/every kraal
- b. ta-ki-βek-a mbuhi kila mu-ki-βaya
 we-PST-put-FV 10goat each/every 18-7-kraal
 we put goats in each/every kraal

Example (16a) shows that the locative morpheme *mu* can function as an independent word since *kila* can appear between it and the noun. Here it functions as an independent head. In (16b), however, the quantifier quantifies over *mu* too. This makes the locative appear like a noun. The locative phrase in Swahili does not behave the same way as the following examples illustrate.

Swahili

- (17) a. *tu-li-wa-wek-a mbuzi kila ch-umba-ni
 we-PST-2OA-put-FV 2goat each 7-room-LOC
 we put the goats in each room
- b. tu-li-wa-wek-a mbuzi katika kila ch-umba
 we-PST-2OA-put-FV 2goat in each 7room
 we put the goats in each room

The way Ndendeule *mu* functions in (16a) is the same as the preposition *katika* in the Swahili example (17b). However, for reasons which are not yet clear to me, quantification over the locative in Swahili is not possible as example (17a) shows.

We have already seen that locatives can trigger agreement. I will now show that this is true of possessive pronouns too. In Swahili, the possessive pronoun must agree with the locative class and cannot agree with the noun class within the locative. This suggests that the possessive pronoun must raise to the Spec of locative to allow for Spec-Head agreement. Therefore, the lower position where it would agree with the N is unavailable.

Swahili

- (18) a. ki-sima-ni kw-etu
 7-well-LOC 17-our
 at our well
- b. *ki-sima-ni ch-etu
 7-well-LOC 7-our
 at our well

The pronoun cannot agree with the noun inside the locative (18b). Suppose we consider *-ni* in Swahili to be a preposition head to which the noun incorporates to form a locative. Once incorporated into the locative head, the phrase can no longer raise to the Spec of the possessive pronoun because it would violate the head movement constraint. This explains the ungrammaticality of the second example. In Ndendeule, however, not all cases behave the same way. The following two pairs show locatives are treated differently.

Possessive Pronouns
Ndendeule

(19) a. ku-n-ghonda yw-ito
17-3-farm 3-our
at/to our farm

b. *ku-n-ghonda kw-ito
17-3-farm 17-our
at our farm

(20) a. *ku-kaya y-ito
17-9-homestead 9-our
at/to our homestead

b. ku-kaya kw-ito
17-9-homestead 17our
at/to our homestead

In (19a) the pronoun agrees with the noun inside the locative. This is grammatical and contrasts with (20a) where agreement with the noun inside the locative is ungrammatical. (19b) and (20b) are cases of agreement with the entire locative. This is ungrammatical in (19b) but grammatical in (20b). The grammaticality does not seem to depend on the class of the noun. The important point is that either the locative or the noun inside the locative can trigger agreement on the possessive pronoun. Bresnan and Mchombo (1987) call agreement with the entire locative "outer concord" and agreement with the noun inside "inner concord". I will explain these differences once the analysis of the locative phrase is made explicit.

With regard to other agreement forms, Ndendeule locatives exhibit an ambiguity between prepositional phrase properties and nominal properties. Adjectives and demonstratives can agree with the locative or with the noun inside the locative. The following examples show the contrast between Ndendeule and Swahili.

Adjectival Phrase

Ndendeule

- (21) a. pa-nyumba pa-kolongwa
16-9house 16-big
at the big homestead
- b. pa-nyumba n-golongwa
16-9house 9-house
at the big house⁵

Swahili

- (22) a. ch-umba-ni mu-kubwa
7-room-LOC 18-big
the big inside of the room/inside the big room
- b. *ch-umba-ni ki-kubwa
7-room-LOC 7-big
inside the big room

Demonstratives

Ndendeule

- (23) a. pa-ki-liḽa p-amba
16-7-well 16-this
here at the well
- b. pa-ki-liḽa ch-enje
17-7-well 7-this
at this well

Swahili

- (24) a. ki-sima-ni h-apa
7-well-LOC this-16
here at the well
- b. *ki-sima-ni h-iki
7-well-LOC this-7
at this well

The adjective and the demonstrative in Ndendeule can agree with either the entire locative (21) and (23) or with the noun. In Swahili, this is not possible. Only the entire locative, not the noun, can agree with the adjective or the demonstratives as shown in (22) and (24).

⁵ I distinguish here between "a homestead", which consists of houses and the entire compound of a family, from "a house", which is just one physical structure.

1.4 The Structure of the Locative Phrase

Any analysis of the locatives must be consistent with the features noted in the foregoing discussion. These are: (i) The locative affix is a head that is responsible for changing the noun into a locative; (ii) Incorporation is an adjoining of the head of the complement to the left of the host (Kayne, 1994); (iii) Agreement is a realization of Spec features on the head; (iv) The locative affix is an addition to the noun class; (v) "Inner" and "outer concord" are found in Ndendeule and only "outer concord" exists in Swahili; (vi) With respect to quantification, Ndendeule allows for quantification of the entire locative as well as quantification of the inner DP. Swahili does not allow for the quantification of the locative or the inner noun.

I adopt the proposal by Carsten (1991, 1993) regarding the structure of the locative in which the locative affix is the head, a preposition. In Ndendeule it is also an independent syntactic word, but in Swahili it is the head to which the noun incorporates. The two are shown in the following tree diagrams.

(25) a. Ndendeule Locative

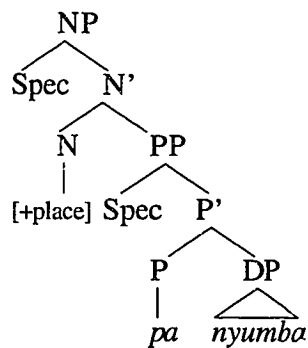

(b) Swahili Locative

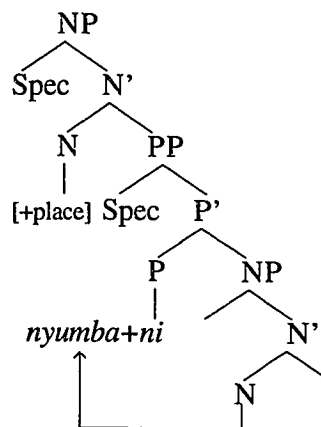

In both languages the locative is headed by an empty head, most probably [place] head. This head selects a PP. The PP in Ndendeule is headed by one of the "class prefixes" while in Swahili it is headed by the locative *-ni*. The two languages differ in that the noun complement incorporates into the preposition head in Swahili. This is consistent with the proposal by Kayne that adjunction is only and always to the left, yielding the surface form *nyumba+ni*. Based on this proposal, the Ndendeule preposition in this case is not an affix; the noun does not incorporate into the preposition because the order is always preposition followed by noun as in *pa-nyumba*. This is further supported by the fact that we can get agreement with a noun that is inside or agreement with the entire locative. The fact that the distributive quantifier can quantify either the entire locative phrase or the internal noun suggests that there is no incorporation into the preposition in Ndendeule.

The complement of the preposition in Ndendeule is a full DP which is why the noun agrees with the demonstrative (23). In Swahili, the complement of the preposition is a noun and not a full DP. Therefore, no genitive and demonstrative agreement with the internal noun is possible. The following two derivations show how this works in Ndendeule.

(26) a. pakiliβa pamba (23a)

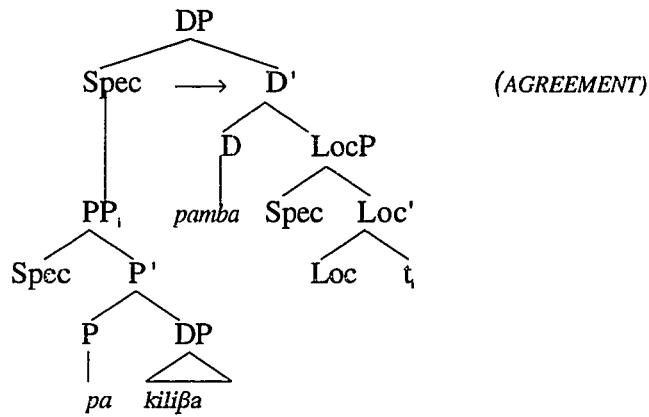

b. pa kiliβa chenje (23b)

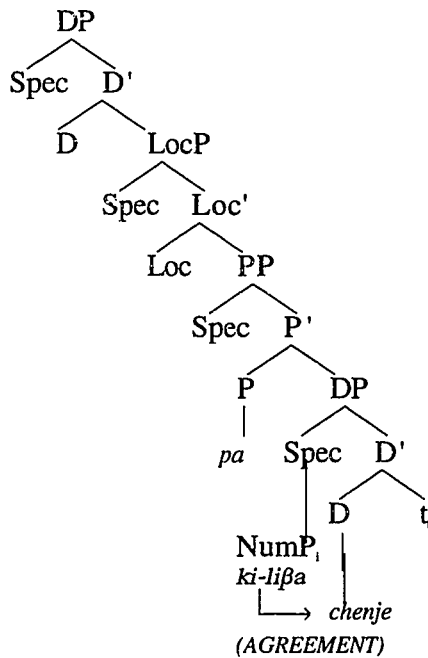

Notice that we have here a DP deep inside another DP. Since head movement must apply in Swahili we get different results. This is because only the PP can move to a higher Spec position as shown below in (27a), the structure of (24) above.

Swahili

(27) a. *kisimani hapa*

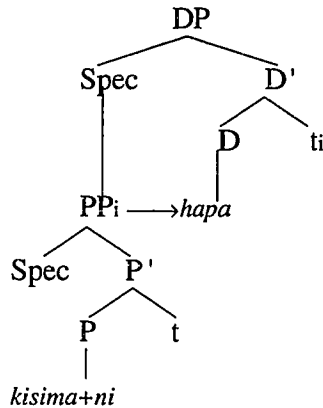

b. **kisimani hiki*

The noun is not the head of the argument which is in the Spec of DP. Therefore there can be no agreement between it and the demonstrative.

To sum up the important points raised in this section: (i) the locative arguments are nominal arguments headed by empty place heads. (ii) The head Loc selects a PP which is headed by the locative affix. (iii) Therefore, the noun complement of the preposition is licensed by the preposition. These features should shed some light on the syntactic behavior of locative applicatives.

2. Locative Applicative Structure

I will now outline the analysis of the locative applicative integrating the applicative structure and the structure of the applicative argument. I will also note the significant differences between locative applicatives and other applicatives (benefactive and instrumental).

In the universal applicative structure I adopted in Chapter 3, the position of all applied objects is in the Spec of the applicative projection. The locative object therefore will occupy this Spec position. When the full structure of the locative is mapped onto this Spec position, the following tree emerges.

(28) The Locative Applicative VP

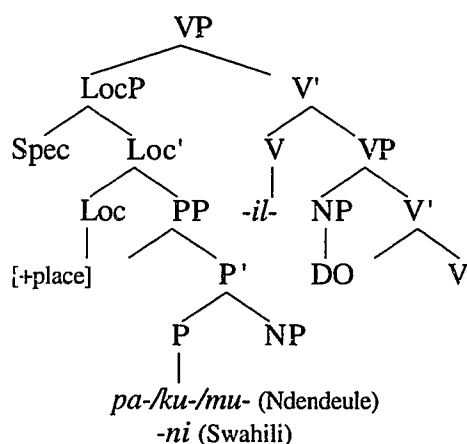

One fundamental distinction between locative applicatives and the other applicatives is that the locative applied argument has a more complex internal structure.

This analysis raises one question: Is the DP selected by the applicative head {-il-} or is it selected by the locative head? The answer to this is that the applicative head selects a LocP. The locative head then selects an appropriate NumP as its complement. Notice that inside the applied object, the locative phrase, there is a DP which is assigned Case by the preposition.

3. Accounting for the Syntactic Properties

This section begins by highlighting the properties of locative applicatives and raising questions that any adequate analysis must answer. These questions are addressed in the second part of the section.

3.1 Syntactic Properties

3.1.1 Object Order

The direct object in locative applicatives must appear before the applied object (i.e. the locative argument). The following examples show this.

Ndendeule

- (29) a. ta-ki-tul-í mbuhi pa-ma-nyahi
 we-PST-skin-APP 9goat 16-6-grass
 we skinned a goat on grass
- b. *ta-ki-tul-í pa-ma-nyahi mbuhi
 we-PST-skin-APP 16-6-grass 9goat
 we skinned on grass a goat

Unlike instrumental applicatives where only one DP appears in postverbal position, both arguments in locative applicatives can appear in postverbal positions. This holds for Swahili as well. The base-generated structure has the locative before the direct object. The surface form arranges the direct object before the locative applicative. The question that arises here is how this order is derived?

3.1.2 Cliticization

The direct object can cliticize but the locative phrase cannot.

Ndendeule

- (30) a. ta-ki-yi-tul-í pa-ma-nyahi
we-PST-9OA-skin-APP 16-6-grass
we skinned it on grass
- b. *?ta-ki-pa-tul-i mbuhi
we-PST-16OA-skin-APP 9goat
we skinned a goat on it.

I pointed out earlier that locative arguments can function as objects and trigger object agreement just like other DPs. Therefore the ungrammaticality of (30b) is not due to the inability of a locative argument to cliticize.

The direct object can clitic double also. In both Swahili and Ndendeule the order of the objects when the direct object is clitic doubled must be DO AO. The following examples from Ndendeule illustrate this.

Ndendeule

- (31) a. ta-ki-yi-tul-í mbuhi pa-ma-nyahi
we-PST-9OA-skin-APP 9goat 16-6-grass
we skinned the goat on grass
- b. *ta-ki-pa-tul-í mbuhi pa-ma-nyahi
we-PST-16OA-skin-APP 9goat 16-6-grass
we skinned a goat on the grass
- c. ??ta-ki-yi-tul-í pa-ma-nyahi mbuhi
we-PST-9OA-skin-APP 16-6-grass 9goat
we skinned the goat on grass
- d. *ta-ki-pa-tul-í pa-ma-nyahi mbuhi
we-PST-16OA-skin-APP 16-6-grass 9goat
we skinned on the grass a goat

The AO DO order is ungrammatical.

A similar question as raised in §3.1.1 above arises here. Why does the order of the objects reverse the base-generated order. Assuming that the highest object cliticizes, why does the direct object cliticize while the locative is unable to cliticize?

3.1.3 Passivization

Passivization is possible for the direct object as well as the applied object as shown in the following examples.

Swahili

- (32) a. mbuzi wa-li-chun-i-w-a ma-nyasi-ni
2goat 2SA-PST-skin-APP-PASS-FV 6-grass-LOC
the goats were skinned on grass
- b. ma-nyasi-ni pa-li-chun-i-w-a mbuzi
6-grass-LOC 16-PST-skin-APP-PASS-FV 2goat
on the grass was skinned a goat
- c. ku-li-chun-i-w-a mbuzi ma-nyasi-ni
17-PST-skin-APP-PASS-FV 2goat 6-grass-LOC
there were skinned goats on the grass

The direct object raises to the Spec of AGRSP in (32a) and the applied object does in (32b). Both are grammatical unlike benefactive applicatives where only one of the objects can passivize.

3.1.4 Topicalization

I use topicalization as an example of wh-construction. Either object can be topicalized as shown in the following examples.

Ndendeule

- (33) a. mbuhi ta-ki-tul-í pa-ma-nyahi
9goat we-PST-skin-APP 16-6-grass
the goat we skinned on the grass
- b. pa-ma-nyahi ta-ki-tul-í mbuhi
16-6-grass we-PST-skin-APP 9goat
on the grass we skinned a goat

In the examples in (33) no clitics have been used. When clitics are involved, the same pattern can be seen. Cliticization is possible in topicalization provided that only the direct object is doubled. This is shown in (34) below.

Ndendeule

- (34) a. mbuhi ta-ki-yi-tul-í pa-ma-nyahi
 9goat we-PST-9OA-skin-APP 16-6-grass
 the goat we skinned on the grass
- b. *mbuhi ta-ki-pa-tul-í pa-ma-nyahi
 9goat we-PST-16OA-skin-APP 16-6-grass
 a goat we skinned on the grass
- c. *pa-ma-nyahi ta-ki-pa-tul-í mbuhi
 16-6-grass we-PST-16OA-skin-APP 9goat
 the grass we skinned the goat on
- d. pa-ma-nyahi ta-ki-yi-tul-í mbuhi
 16-6-grass we-PST-9OA-skin-APP 9goat
 on grass we skinned the goat

These examples show that when the direct object is cliticized, either object can be topicalized as (34a,d) show. Examples (34b,c) are ungrammatical because the applied object cannot cliticize.

3.2 VP Raising

From the above discussion and the earlier discussion on the syntactic properties of applicatives (cf. Chapter 2), we learn that locative applicatives are similar to instrumental applicatives in at least three respects: (i) the direct object can cliticize; (ii) the direct object can also get reciprocal and reflexive interpretation while the applied object cannot; (iii) wh-extraction of either object is possible. In view of the universal applicative structure, the two former properties suggest some movement that results in the direct object getting

closer to the clitic position, and including it in the binding domain of the subject. My proposal here will deal with what and how the DO moves. I am not certain as to the why. Therefore, I defer that question to further investigation.

The lower VP moves to a Spec position which is higher than the applicative projection. The following tree diagram shows the derivation.

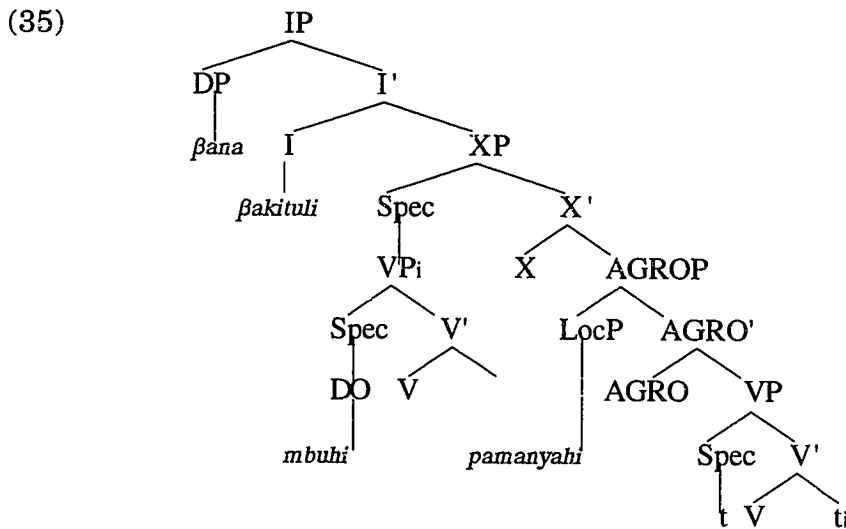

The lower predicate attaches to the Spec of XP. This derivation does not interfere with VP ellipsis. The theme/patient now appears as a constituent in the Spec of XP. Therefore it linearly precedes the locative argument. I assume that to go to the clitic position the object must obey the principle of shortest move (Chomsky, 1993). The direct object is the one that can make the shortest move to the clitic. The applied object cannot because of the intervening Spec of AGROP which is already occupied by the VP.

Consider now the binding domain of the subject. The direct object is in this domain. The applied object is no longer accessible as shown in the following structure.

(36)

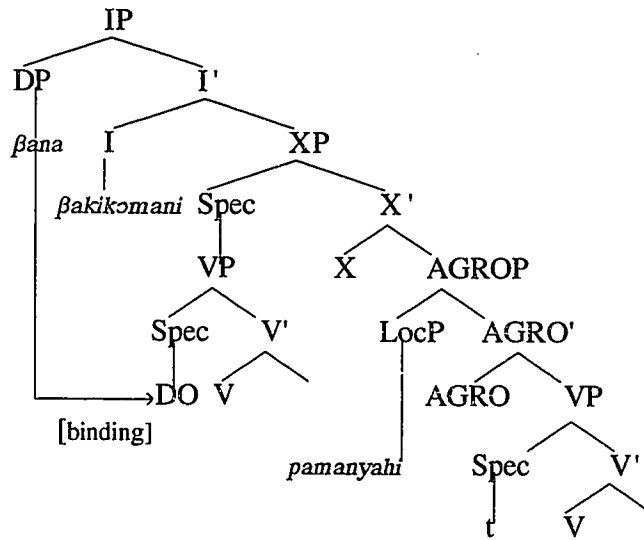

I conclude that in this structure the direct object is a potential binder for the locative since it c-commands the locative in Kayne's definition of c-command (Kayne, 1994). As reflexive binding is only possible in the clitic position, the locative argument does not reflexivize because the direct object is the one that can make the shortest move to the clitic and reflexivize.

Finally, wh-movement of either object is possible because the direct object is in a Case position and the locative does not require Case. There exist no barriers between the extraction site of the arguments and the landing site, in the Spec of CP.

3.3 *Passive and Locative Inversion*

I have already illustrated the fact that in locative applicatives either object can passivize. This appears similar to what is commonly known as locative inversion. In locative inversion cases of transitive verbs, the locative can passivize even though there is a direct object that is adjacent to the verb. The DO can cliticize and passivize. This striking parallel calls for a detour into locative inversion.

In Ndendeule and Swahili, as in other Bantu languages, there are constructions in which a locative phrase is the subject and an argument of the verb appears as an object. The following examples illustrate this.

Ndendeule

- (37) a. ku-ki-liḽa ku-na li-holo
17-7-well 17SA-with 5-tortoise
at the well there is a tortoise
- b. mu-ki-liḽa mu-tumbuk-í li-holo
18-7-well 18SA-fall into-PERF 5-tortoise
into the well has fallen a tortoise

As subject agreement on the verb shows, the locative phrase is in a position where the subject is licensed. Bresnan and Kanerva (1989) provide additional evidence suggesting that the locative phrase is the subject in Chichewa. The Chichewa locatives are similar to Ndendeule locatives⁶. This subject property is the first property of locative inversion.

The second property, also evident in the two examples, is that what appears to be the logical subject appears after the verb. Bresnan and Kanerva consider this argument an object. However, the postverbal argument cannot

⁶ Thwala (1996) points out that locatives in SiSwati are different from locatives in Chichewa. The locative phrase in SiSwati is a prepositional phrase but in Chichewa it is a DP.

trigger object agreement although the fact that it can passivize suggests it is VP internal. The most important point is that it appears in a postverbal position.

The third property is that locative inversion applies to verbs which do not have an external argument. Thus we have unaccusative verbs and passive verbs. Verbs with external arguments do not trigger this inversion. The following examples contrast an unaccusative case (38a) and an intransitive case (38b)

Swahili

- (38) a. m-taa-ni ku-me-ingi-a w-ezi
 3-neighborhood-LOC 17SA-PERF-enter-FV 2-thief
 in the neighborhood have come thieves
- b. *m-taa-ni ku-me-zungumz-a w-ezi
 3-neighborhood-LOC 17SA-PERF-talk-FV 2-thief
 in the neighborhood have talked the thieves

Locative inversion results in a grammatical sentence when the verb is unaccusative (38a). The sentence is ungrammatical for the intransitive verb (38b). Passivization of the locatives suggests that verbs other than unaccusatives are involved. The following examples illustrate this.

Swahili

- (39) a. pesa zi-li-okot-w-a ki-sima-ni
 10money 10SA-PST-pick-PASS-FV 7-well-LOC
 the money was found at the well
- b. ki-sima-ni ku-li-okot-w-a pesa
 7-well-LOC 17SA-PST-pick-PASS-FV 10money
 at the well was found money

In (39a) the direct object is passivized, but in (39b) it is the locative which is passivized. Both sentences have the same internal argument, "money".

However, in (39a) the internal argument is the subject of the passive sentence and the locative phrase appears as an adjunct. In (39b) the internal argument is in a postverbal position and the locative phrase is the one that has become the subject.

The essential feature, once more, is that the verb has only an internal argument. This can be stated as a generalization on locative inversion:

(40) Generalization on Locative Inversion

Locative inversion can take place iff the verb lacks an external argument.

Passive verbs, like unaccusatives, have only the internal argument. They are therefore legitimate candidates for locative inversion. This means (i) in different environments the internal argument may either raise to subject position as in unaccusative sentences or passive sentences or (ii) it can remain in postverbal position and the subject position will be filled by a locative phrase. Notice also that for the transitive verbs there are two possible movements: One is the passivization of the internal argument and the other is the passivization of the locative phrase.

The generalization in (40) applies to two kinds of constructions in which the external argument is missing. One is cases, like the passive, where the external object is phonologically null but the argument is implicit. The other kind is when the verb lacks the external argument structurally and semantically as is the case with unaccusatives and statives.

If we assume that the object in passive constructions raises to the subject position in order to satisfy the Extended Projection Principle, we must

have a position at which such an object is licensed when it does not move to the subject position as in (39b) above. Kural (1996) assumes that the object can be licensed in the Spec of an AccP. When the object does not move from the Spec of this licensing position the Extended Projection Principle must be satisfied by other means. It appears there are two options for filling the subject position of a passive construction: (i) raising the internal object to the subject position as in (39a), and (ii) fill the subject position with a pleonastic subject or an expletive (39b). One form of these in Ndendeule and Swahili is a locative prefix. This suggests that the locative "subject" as found in locative inversion can be obtained independent of the internal argument structure of the VP. That is, we could get a locative subject even if it was not the applied object.

Passivization of the direct object is made possible by the movement of the lower predicate. This places the direct object closer to the subject position as the following derivation shows. I include the passive head in the I.

(41)

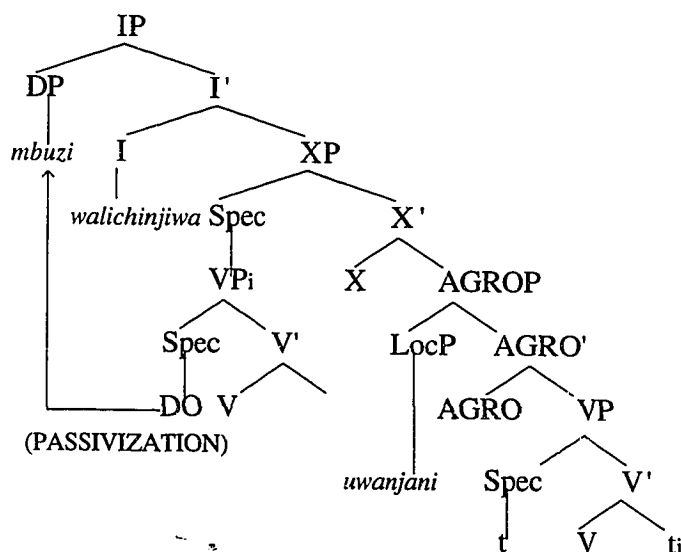

I suggest that what appears to be passivization of the locative argument results from adjunction of the locative to the AGRSP. Since the predicate is passive, it appears like the locative is passivized. It has simply moved to the subject position as shown in the following derivation.

(42)

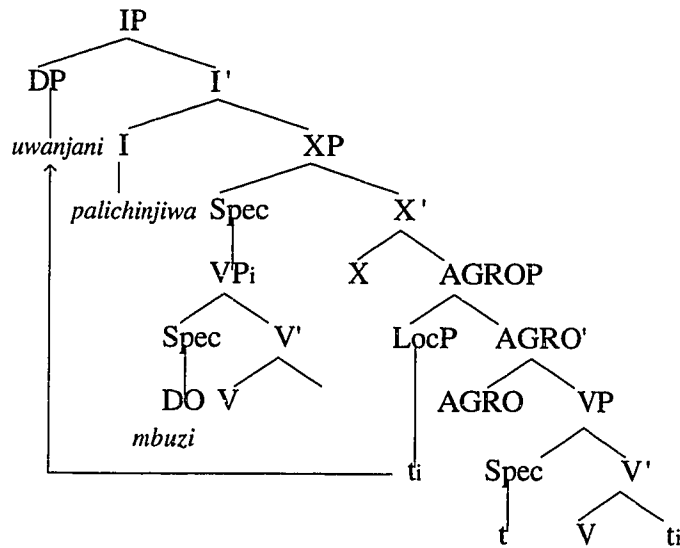

4. Conclusion

In this chapter I have examined locative applicatives and argued that the uniqueness of this type of applicative is due to the locative argument. I argued that the locative argument exhibits distributional and agreement properties of both DPs and PPs. I concluded by showing that the locative argument is a nominal phrase that has a PP complement.

The direct object in locative applicatives exhibit object properties such as linear precedence, cliticization, passivization and can be interpreted as reciprocal or reflexive. These properties are associated with the highest object. In the structure proposed in (28) the applied object is the highest in the base-generated structure. I suggested that these features are acquired by the direct

object because the lower VP has pied-piped to a Spec position higher than the applicative projection. In this way the direct object is closer to clitic position and is in the binding domain of the subject which restricts binding to the direct object.

Passivization in instrumental applicatives is similar to locative inversion of transitive verbs. In such cases, either the direct object or the locative may passivize. Unlike the other positions to which the direct object moves (accusative and clitic), passivization is movement to an A-position. I have argued that the direct object may raise to subject position like other cases of passivization. But the locative argument can only adjoin to the subject position. This distinction is possible if we assume that there is a licensing position below the passive projection.

Bibliography

- Alsina, Alex and Sam Mchombo. 1990. The Syntax of Applicatives in Chichewa: Problems for a Theta Theoretic Asymmetry. *Natural Language and Linguistic Theory* 8: 493-506.
- Alsina, Alex and Sam Mchombo. 1993. Object Asymmetries and the Chichewa Applicative Construction. In Sam Mchombo (ed). *Theoretical Aspects of Bantu Grammar*. Stanford: Center for the Study of Language and Information.
- Alsina, Alex. 1990. Where's the Mirror Principle? Ms. Stanford.
- Alsina, Alex. 1992. On the Argument Structure of Causatives. *Linguistic Inquiry*, Vol. 23, 4:517-555.
- Ashton, Ethel O. (1947) *Swahili Grammar (Including Intonation)*. London: Longmans, Green and Co.
- Baker, Mark, Kyle Johnson and Ian Roberts. 1989. Passive Arguments Raised. *Linguistic Inquiry* 20, 2:219-251.
- Baker, Mark. 1985. The Mirror Principle and Morphosyntactic Explanation. *Linguistic Inquiry* 16:373-416.
- Baker, Mark. 1988. Theta Theory and the Syntax of Applicatives in Chichewa. *Natural Language and Linguistic Theory* 6, 3: 353-389
- Baker, Mark. 1988a. *Incorporation: A Theory of Grammatical Function Changing*. Chicago: Chicago University Press.
- Baker, Mark. 1988b. Theta theory and the syntax of applicatives in Chichewa. *Natural Language and Linguistics Theory* 6:353-389.
- Baker, Mark. 1990. Elements of a Typology of Applicatives in Bantu. In J. Hutchison and V. Manfredi (eds) 1990. *Current Approaches to African Linguistics* 7. Dordrecht: Foris.

- Baker, Mark. 1992. Thematic Conditions on Syntactic Structures: Evidence from Locative Applicatives.. In Ida M. Roca (ed). *Thematic Structure: Its Role and Grammar*. New York: Foris.
- Barrett-Keach, Camillia N. 1987. Phonological Allomorphy in Swahili: On the Form of Inanimate Pronominal Clitics. *Studies in African Linguistics* 18, 3: 263-298
- Barss, Andrew and Howard Lasnik. 1986. A Note on Anaphora and Double Objects. *Linguistic Inquiry* 17: 347-354.
- Batibo, Herman M. and Franz Rottland. 1992. The minimality condition in Swahili word forms. *Afrikanistische Arbeitspapiere*, 2: 63-88.
- Beghelli, Filippo and Tim Stowell. 1995. The Direction of Quantifier Movement. ms. UCLA.
- Belletti, Adriana. 1988. The Case of Unaccusatives. *Linguistic Inquiry*, 19,1: 1-34.
- Bergvall, Victoria L. 1986. A Typology of Empty Categories for Kikuyu and Swahili. In Gerrit J. Dimmendaal (ed.). *Current Approaches to African Linguistics*, III. Dordrecht : Foris.
- Bresnan, Joan and Jonni Kanerva. 1989. Locative Inversion in Chichewa: A Case Study of Factorization in Grammar. *Linguistic Inquiry* 20:1-50.
- Bresnan, Joan and Lioba Moshi. 1990. Object Asymmetries in Comparative Bantu. *Linguistic Inquiry* 21, 2:147-185.
- Bresnan, Joan and Sam A. Mchombo. 1987. Topic, Pronoun, and Agreement in Chichewa. In Iida Masayo, Wechsler Stephen and Zec Draga (eds.). *Working Papers in Grammatical Theory and Discourse Structure: Interactions of Morphology, Syntax, and Discourse*. Chicago : University of Chicago Press.

- Bresnan, Joan. 1991. Locative Case vs. Locative Gender. In Laurel A Sutton, Christopher Johnson and Ruth Shields (eds.). *Proceedings of the Seventeenth Annual Meeting of the Berkeley Linguistics Society*. February 15-18, 1991: General Session and Parasession on the Grammar of Event Structure. Berkeley : Berkeley Ling. Soc.
- Burzio, Luigi. 1986. *Italian Syntax*. Dordrecht: Reidel.
- Carstens, Vicki. 1991. *The Morphology and Syntax of Determiner Phrases in Kiswahili*. Doctoral dissertation, UCLA.
- Carstens, Vicki. 1993. On Nominal Morphology and DP Structure. In Sam Mchombo (ed). *Theoretical Aspects of Bantu Grammar*. Stanford: Center for the Study of Language and Information.
- Chomsky, Noam. 1977. On Wh-Movement. In Peter Culicover, Thomas Wasow and Adrian Akmajian, (eds), *Formal Syntax*. New York: Academic Press.
- Chomsky, Noam. 1981. *Lectures on Government and Binding*. Dordrecht: Foris.
- Chomsky, Noam. 1982. *Some Concepts and Consequences of the Theory of Government and Binding*. Cambridge: MIT Press.
- Chomsky, Noam. 1986a. *Knowledge of Language*. Praeger: New York.
- Chomsky, Noam. 1986b. *Barriers*. Cambridge: MIT Press.
- Chomsky, Noam. 1991. Some Notes on Economy of Derivation and Representation. In Robert Freidin (ed), *Principles and Parameters in Comparative Grammar*. Cambridge: MIT Press.
- Chomsky, Noam. 1993. Minimalist Program. In Kenneth Hale and Sam Keyser (eds). *The View from Building 20*. Cambridge: MIT Press.
- Chomsky, Noam and Howard Lasnik. 1993. The Theory of Principles and Parameters. In Joachim Jacobs, Arnim von Stechow, Wolfgang

- Sternefeld and Theo Vennemann. *Syntax: An International Handbook of Contemporary Research*. Berlin: Walter de Gruyter.
- Cole, Peter and Jerrold N. Sadock (eds). 1977. *Syntax and Semantics*, Vol 8. New York: Academic Press.
- Demuth, Katherina 1990. Locatives, impersonals, and expletives in Sesotho. *The Linguistic Review* 7, 3: 233-249.
- Di Sciullo, Anna Maria and Edwin Williams. 1987. *On the Definition of Word*. Cambridge: MIT Press.
- Fabb, Nigel. 1988. English Suffixation is Constrained only by Selectional Restrictions. *Natural Language and Linguistic Theory* 6: 527-539.
- Farsi, S. S. 1958. *Swahili Sayings*. Dar es Salaam: East African Literature Bureau.
- Gerdts, Donna B. and Lindsay Whaley 1991. Locatives vs. instrumentals in Kinyarwanda. In Kathleen Hubbard (ed). *Proceedings of the Seventeenth Annual Meeting of the Berkeley Linguistic Society: Special Session on African language structures*. Berkeley: Berkeley Linguistic Society.
- Givon, Talmy. 1972. *Studies in Chibemba and Bantu Grammar*. *Studies in African Linguistics*, supp. 3.
- Grimes, Barbara F. (ed.) 1992. *Ethnologue*. Dallas: Summer Institute of Linguistics.
- Guthrie, Malcom. 1967-1971. *Comparative Bantu* Vol. I-IV. Farnborough: Gregg Press.
- Guthrie, Malcom. 1948. *The Classification of the Bantu Languages*. London: International African Institute.
- Guthrie, Malcom. 1970. The Status of Radical Extensions in Bantu Languages. In Malcom Guthrie (ed) *Collected Papers on Bantu Linguistics*.. London: Gregg International Publishers.

- Hale, Kenneth and Sam J. Keyser. 1993. On Argument Structure and the Lexical Expression of Syntactic Relations. In K. Hale and S. Keyser (eds). *The View from Building 20*. Cambridge: MIT Press.
- Harford, Carolyn 1991. Object Asymmetries in Kitharaka. In Kathleen Hubbard (ed), *Proceedings of the Seventeenth Annual Meeting of the Berkeley Linguistic Society*: Special session on African language structures. Berkeley: Berkeley Linguistic Society.
- Harford, Carolyn. 1993. The Applicative in Chishona and Lexical Mapping Theory. In S. Mchombo (ed). *Theoretical Aspects of Bantu Grammar*. Stanford: Center for the Study of Language and Information.
- Hinnebusch, Thomas. 1981. Northeastern Coastal Bantu. In: Thomas Hinnebusch, Derek Nurse and Martin Mould. *Studies in the Classification of Eastern Bantu Languages*. Hamburg: Helmut Buske Verlag.
- Hoffman, Mika C. 1991. *The Syntax of Argument-Structure Changing Morphology*. Doctoral dissertation, MIT.
- Hyman, Larry 1993. Conceptual Issues in the Comparative Study of the Bantu Verb Stem. In Salikoko Mufwene and Lioba Moshi (eds), *Topics in African Linguistics*, Amsterdam: John Benjamin's Publishing Company.
- Hyman, Larry and Alessandro Duranti. 1982. On the Object Relation in Bantu. In Paul Hopper and Sandra Thompson (eds). *Studies in Transitivity (Syntax and Semantics 15)*. New York: Academic Press.
- Hyman, Larry and Francis Katamba 1991. Cyclicity and Suffix Doubling in the Bantu Verb stem. In Kathleen Hubbard (ed), *Proceedings of the Seventeenth Annual Meeting of the Berkeley Linguistic Society*. Special Session of African Language Structures, 134 -144. Berkeley Linguistic Society 17.

- Hyman, Larry M., Alessandro Duranti and Malillo Morolog 1980. Towards a typology of the direct object in Bantu. In Luc Bouquiaux (ed). *L'expansion Bantoue*. Paris: SELAF. pp 563-582.
- Jackendoff, Ray. 1977. *X-bar Syntax: A Study of Phrase Structures*. Linguistic Inquiry Monograph Two. Cambridge: MIT Press.
- Jaeggli, Osvald. 1986. Passive. *Linguistic Inquiry* 17, 4:587-633.
- Kapinga, M.C. 1981. *Sarufi Maumbo ya Kiswahili Sanifu*. Taasisi ya Uchunguzi wa Kiswahili, Chuo Kikuu cha Dar es Salaam.
- Kayne, Richard. 1984. *Connectedness and Binary Branching*. Dordrecht: Foris.
- Kayne, Richard. 1994. *The Antisymmetry of Syntax*. Cambridge: MIT Press.
- Kidima, Lukowa. 1987. Object Agreement and Topicality Hierarchies in Kiyaka. *Studies in African Linguistics*, 18, 2: 175-209.
- Kimenyi, Alexandre 1995. Kinyarwanda Applicatives Revisited. Paper presented at the 8th Niger-Congo Syntax Semantics Workshop. Boston University, 25-26 October, 1995.
- Kimenyi, Alexandre. 1980. *A Relational Grammar of Kinyarwanda*. Berkeley: University of California Press.
- Kinyalolo, Kasangati K. 1987. KiLega An-aphor: Reciprocal and Indefinite. Paper Presented at the 18th Conference on African Linguistics, April 23-26, UQAM: Montreal.
- Kinyalolo, Kasangati. 1991. *Syntactic Dependencies and the Spec-Head Agreement Hypothesis in Kilega*. Doctoral dissertation, UCLA.
- Kisserberth, Charles and Mohammed Abasheikh. 1977. The Object Relationship in Chi-mwi:ni, a Bantu Language. In Peter Cole and Jerrold N. Sadock (eds).
- Koopman, Hilda. 1984. *The Syntax of Verbs: From Verb Movement Rules in the Kru Languages to Universal Grammar*. Dordrecht: Foris Publications.

- Koopman, Hilda. 1994. Licensing Heads. In D. Lightfoot and N. Hornstein (eds). *Verb Movement*. Cambridge: Cambridge University Press.
- Koopman, Hilda. 1996. On Verbs That Fail to Undergo V-Second. *Linguistic Inquiry*.
- Koopman, Hilda and Dominique Sportiche. 1991. The Position of Subjects. *Lingua* 85: 211-258.
- Kural, Murat. 1993. Instrumentals and Causatives. ms. UCLA.
- Kural, Murat. 1996. *Verb Incorporation and Elementary Predicates*. Doctoral dissertation, UCLA.
- Lakoff, George. 1968. Instrumental Adverbs and the Concept of Deep Structure. *Foundations of Language* 4, 1:4:29.
- Larson, Richard. 1988. On Double Object Constructions. *Linguistic Inquiry* 19:335-91.
- Levin, Beth and Malka Rappaport. 1988. Non-event -er Nominals: A Probe into Argument Structure. *Linguistics* 26: 1067-1083.
- Li, Yafei. 1990. X⁰-Binding and Verb Incorporation. *Linguistic Inquiry* 21, 3:399-426.
- Lobeck, Anne. 1993. Strong Agreement and Identification: Evidence from Ellipsis in English. *Linguistics*, 31:777-811.
- Loogman, Alfons. 1965. *Swahili Grammar and Syntax*. Pittsburgh: Duquesne University Press.
- Mahajan, Anoop. 1991. Clitic Doubling, Object Agreement and Specificity. *Proceedings of the North Eastern Linguistics Society Annual Meeting* 21:263-277.
- Marantz, Alec. 1984. *On the Nature of Grammatical Relations*. Cambridge: MIT Press.

- Marantz, Alec. 1993. Implications of the Asymmetries in Double Object Constructions. In Sam A. Mchombo (ed). *Theoretical Aspects of Bantu Grammar*. Stanford: Center for the Study of Language and Information.
- McCloskey, James. 1991. Clause Structure, Ellipsis and Proper Government in Irish. *Lingua* 85:259-302.
- Mchombo, Sam A. (ed) 1993. *Theoretical Aspects of Bantu Grammar*. Stanford: Center for the Study of Language and Information.
- Mchombo, Sam A. 1980. Dative and Passive: An Argument for a Surface Grammar. *Linguistic Analysis* 6, 2:97-113.
- Mchombo, Sam A. 1991. Reciprocalization in Chichewa: A Lexical Account. *Linguistic Analysis* 21, 1-2:3-22.
- Mchombo, Sam. 1993. Reflexive and Reciprocal in Chichewa. In S. Mchombo (ed). *Theoretical Aspects of Bantu Grammar*. Stanford: Center for the Study of Language and Information.
- Meeussen, A.E. 1967. Bantu grammatical reconstruction. *Africana Linguistica* III, 61:79-121
- Meinhof, C. 1932. *Introduction to the Phonology of the Bantu Languages*, translated and revised (from Meinhof 1910) by N. J. van Warmelo. Berlin: Dietrich Reimer/E. Vohsen.
- Morolong, Malilo and Larry Hyman. 1977. Animacy, Objects, and Clitics in Sesotho, *Studies in African Linguistics* 8: 199-218.
- Ngonyani, Deogratias. 1994. A Classification of Southern Tanzanian Languages. MA thesis, UCLA.
- Ngonyani, Deogratias. 1995. Towards a Typology of Applicatives in Bantu. Paper presented at 26th Annual Conference on African Linguistics, 24-26 March, 1995. Los Angeles.

- Nurse, Derek. 1988. The Diachronic Background to the Language Communities of Southwestern Tanzania. *Sprache und Geschichte in Afrika*, 9: 15-115.
- Nurse, Derek and Thomas J. Hinnebusch. 1993. *Swahili and Sabaki: A Linguistic History*. University of California Press: Berkeley.
- Otani, Kazuyo and John Whitman. 1991. V-Raising and VP-Ellipsis. *Linguistic Inquiry*, 22, 2: 345-358.
- Pollock, Jean-Yves. 1989. Verb Movement, Universal Grammar and the Structure of IP. *Linguistic Inquiry* 20:365-424.
- Polomé, Edgar C. 1967. *Swahili Language Handbook*. Washington: Center for Applied Linguistics.
- Port, Robert F. 1981. The Applied Suffix in Swahili. *Studies in African Linguistics*, 12,1: 71-82.
- Port, Robert F. and Kenneth N. Shepardson. 1982. Morphophonemics of Swahili Verb Suffixes. *Studies in African Linguistics*, 13,3: 249-271.
- Roeper, Thomas. 1987. Implicit Arguments and the Head-Complement Relation. *Linguistic Inquiry*, 18:2, 267-310.
- Rugemalira, Josephat 1991. What is a Symmetrical Language? In Kathleen Hubbard (ed). *Proceedings of the Seventeenth Annual Meeting of the Berkeley Linguistic Society: Special session on African language structures*. Berkeley: Berkeley Linguistic Society.
- Rugemalira, Josephat M. 1993. Bantu Multiple 'Object' Constructions. *Linguistic Analysis*, 23, 3-4: 226-252.
- Rugemalira, Josephat M. 1994. The Case against the Thematic Hierarchy. *Linguistic Analysis*, 24, 1-2: 62-81.

- Scotton, Carol M. 1967. *Aspects of the Swahili Extended Verb System with Special Reference to Some Deep Structure Syntactic and Semantic Restrictions*. Doctoral dissertation
- Sportiche, Dominique. 1990. Movement, Agreement and Case Assignment. Ms. UCLA.
- Sportiche, Dominique. (to appear) Johan Rooryck and Laurie Zaring (eds). *Phrase Structure and the Lexicon*. IULC Press. Bloomington, Indiana.
- Sportiche, Dominique. 1983. Bete Reciprocals and Clitic Binding. In J. Kaye, H. Koopman, D. Sportiche and A. Dugas (eds). *Current Approaches to African Linguistics*. Vol 2: Dordrecht: Foris.
- Stowell, Tim. 1981. *Origins of Phrase Structure*. Doctoral dissertation, MIT.
- Thwala, Nhlanhla. 1996. *A Generative Grammar of SiSwati: The Morphology and Syntax of Nouns and Verbs*. Doctoral dissertation, UCLA.
- Travis, Lisa. 1984. *Parameters and Effects of Word Order Variation*. Doctoral dissertation, MIT.
- Trithart, M. L. 1983. *The Applied Affix and Transitivity: A Historical Study in Bantu*. Doctoral dissertation, UCLA.
- Vitale, Anthony. 1981. *Swahili Syntax*. Dordrecht: Foris.
- Wald, Benji. 1975. Animate Concord in Northeast Coastal Bantu. *Studies in African Linguistics*, 6, 3:267-314.
- Williams, Edwin. 1981. On the Notions "Lexically Related" and "Head of a Word". *Linguistic Inquiry*, 12, 2: 245-274.